

**STREETLIFE®**



**THE OUTDOOR CONCEPT**  
COLLECTION 2018-2019

# Streetlife Collection 2018-2019

## **STREETLIFE BV**

### **Head Office**

Herengracht 36  
2312 LD Leiden  
The Netherlands  
T +31 (0)71 333 33 33  
streetlife@streetlife.nl  
www.streetlife.nl

## **STREETLIFE Europe**

UK +44 (0)20 30 20 1509  
enquiriesUK@streetlife.nl  
DE +31 (0)71 333 33 60  
Auskunft@streetlife.nl  
FR +33 (0)01 83 71 01 71  
demandes@streetlife.nl

## **STREETLIFE Studio Scandinavia**

Malmö, Sweden  
T +46 (0)41 677 50 53  
studioscandinavia@streetlife.nl

## **STREETLIFE America LLC**

Philadelphia, PA  
T 001 215 247 0148  
streetlife@streetlifeamerica.com

## **STREETLIFE Middle East**

by WTB Group, Dubai - UAE  
T +971 (0)4 88 607 00  
streetfurniture@wtburden.ae

More information is available on our website:

- the complete Streetlife Collection
- online catalogue (in PDF): available in Nederlands, English, Deutsch & Français
- product search tool: The Product Selector
- recent projects and product photos

Follow STREETLIFE BV on  



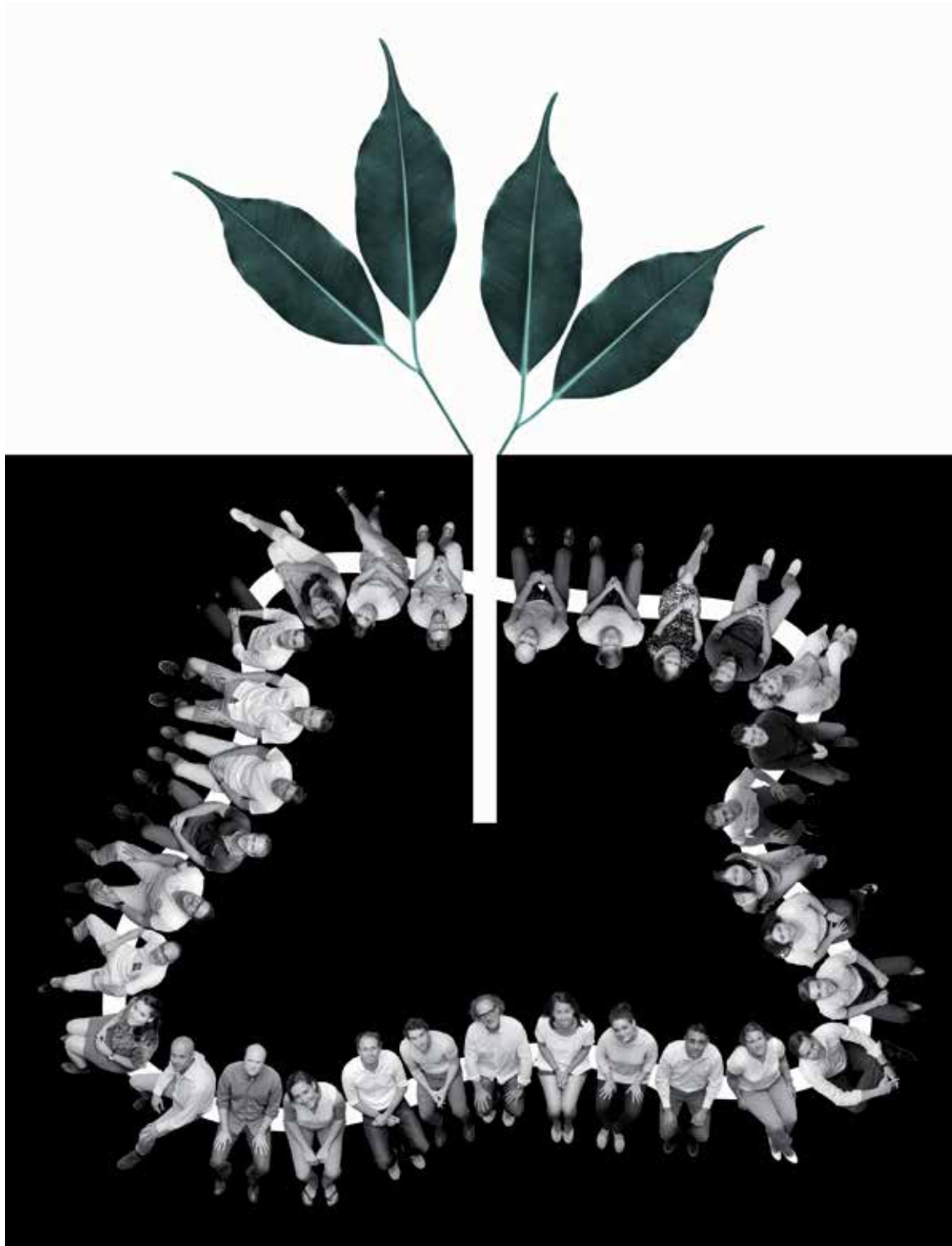

## The Streetlife Team

People really respond to the Streetlife Collection – and that is something we are proud of. Our Collection offers products with a natural look unlike anything else on the market today. The 2018-2019 Collection has been updated with 34 new products.

We work with a team of highly trained consultants, architects and designers. They can quickly translate your concerns and ideas into a design that will create the right atmosphere and physical space for your needs. Our experts know how to offer inspiration, contribute solutions and propose budgetary alternatives.

In addition to the options provided in our Streetlife Collection, we also work on tailor-made design projects. Both our experienced product designers and our Bee Public design lab for new talent can help you achieve the right form and function.

photo:  
**Space for Nature** (2017)  
*The Streetlife Team* by Miro Švolík (CZ)

### 1 Rough Benches & Picnic Sets

- Rough&Ready
- Drifter
- Heavy-Heavy
- Stone

### 2 Fine Benches & Picnic Sets

- Solid
- Cliffhanger
- Horse Shoe
- Highlife III
- Long&Lean
- New Standard
- Solitude
- Olympic Wave

### 3 Green Benches, Tree Isles & Podiums

- Tree Isles
- Surf Isles
- Podium Isles
- Raised Borders

### 4 Tree Planters

- TreeTec®
- Planters

### 5 Tree Grilles & Guards

- Tree Grilles
- Tree Outlines
- Press Grating
- Cortile System
- Tree Guards

### 6 Bins, Bollards & Bicycle Parking

- Bins
- Bollards
- Bicycle Parking

### 7 Shades, Pillars & Parklets

- Shades
- Parklets
- Pillars

### 8 Bridges, Jetties & Decking

- Bridges
- Fixed Jetties
- Floating Jetties
- Decking





## The Outdoor Concept

Streetlife speaks the language of landscape architects and spatial planners. We supply the building elements for landscape or urban plans. We consider it a privilege to be able to work with leading architects and cities, and, of course, to contribute towards the realization of high-quality public spaces.

Browse our 2018-2019 Collection to select any product and customize it to your specifications. Our Collection offers a wide and versatile range of product choices. We have taken care in creating this brochure and hope you find it easy to navigate through our product selection. If you have any questions or would like any additional information on our products, please do not hesitate to contact us.

Our organization is not only compact and efficient, but also supremely skilled in its sector, while devoting great attention to the wishes of the customer. Particularly nowadays, success depends on knowledge and quality. Streetlife is a partner for products that you can rely on. We can communicate in English, but also in Dutch, French, German, Spanish and Swedish.

We eagerly await your queries.

Peter Krouwel  
Designer & Director of Streetlife

Streetlife has an in-house design and engineering team led by Peter Krouwel. The innovative designs have received several design awards: Good Industrial Design, Nomination for The Dutch Design Prize, Nomination for The German Design Prize.

Peter Krouwel was a partner of npk design office for 25 years and, as such, responsible for the new-style post boxes (TNT) and the national signposting of the ANWB Motorists' Association, among other prize-winning designs. He was also a member of the Academic Council of the Design Academy Eindhoven for five years.







## FSC® Hardwood

In 1993, the Forest Stewardship Council was founded. This is an international network for promoting responsible forest management. FSC® sets an international standard for good forest management and has a seal of approval associated with this standard. The FSC® seal of approval provides assurance that the raw materials in wood and paper products have come from sustainably managed forests where attention is given to the ecological, social and economic aspects (such as working conditions and fair wages for local workers) and bio-diversity is effectively protected. FSC® is therefore not a government seal of approval. FSC® is an important instrument in combatting illegal felling and deforestation.

The seal of approval demonstrates that a company is conforming to the guidelines of the Forest Stewardship Council and that its policy is approved.



Streetlife is certified by the FSC® as a 'Chain Of Custody' (COC). This means that the wood, or wood product, is administratively tracked through every stage of its processing and distribution. This means the (end) user can rest assured that the material in a product really does come from sustainably managed forests and has been processed by companies that subscribe to the FSC®'s norms and values. Streetlife is certified for 3 variants: FSC®-100% (all the wood from an FSC®-approved source), FSC®-Mix (partly from an FSC®-approved source) and FSC®-Recycled (wood that is recycled under specific conditions).



The mark of responsible forestry

## The choice of Good Wood

What are the determining factors when opting for wood as the material of choice for street furniture? Aesthetically, the natural character and colour variations (polychrome) of wood are unequalled. Moreover, wood's insulating properties make it the ideal sitting surface in any climate. Metal or stone benches quickly become too cold or too hot to function as pleasant contact surfaces and are therefore unpopular.

High-quality hardwood species can be applied untreated (no chemicals increasing their low maintenance) and have a very long lifespan. Due in part to smart construction details (no water pockets), rot will not appear. Certain wood species have high density and hardness which makes them resistant to vandalism. Streetlife has broad experience with dimensioning, liveliness, sustainability and availability. In line with our ambition to always strive for the best quality, we consider FSC®-100% hardwood the best choice for our products.

To reduce transportation and also from an ecological point of view, opting for a local material and/or local production is an obvious consideration. Streetlife has experimented over the years and has practical experience with local wood species and new composite materials. The European hardwood species Robinia (or the North American Black Locust) is suitable for certain projects, despite its moderate liveliness and dimensioning limitations. The large timber sizes used in manufacturing the new Heavy-Heavy range of benches are made of W-Wood®: a pine wood which is intensively primed with a natural wax, giving W-Wood® its durability. This means that W-Wood has a long lifespan. FSC® reclaimed Douglas wood makes a good alternative for the Heavy-Heavy benches, especially in humid regions. This Douglas wood has seen decades of use on ocean ships.

The Drifter benches use 30-to-40-year-old hardwood mooring posts from Dutch ports. These antique beams may feature scars, cracks and sometimes holes; it's all part of their charm.

Do you have any questions about the applications of wood, or doubts about its suitability in terms of hardness, possible cracks, ageing or appearance? Our staff will be happy to provide you with expert advice.

## Standardisation of wood sizes



- Drifter**  
Wood size 30x30cm - 12"x12"  
wide spacing



- Heavy-Heavy**  
Wood size 15x21cm - 5.9"x8.2"  
wide spacing



- Rough&Ready**  
Wood size 7x15cm - 2.8"x5.9"  
wide spacing



- Solid**  
Wood size 7x7cm - 2.8"x2.8"  
narrow spacing



- Olympic Wave, Cliff Hanger**  
Wood size 5x5cm - 1.9"x1.9"  
narrow spacing



- The New Standard, WoodTop, Long&Lean**  
Wood size 3,5x5,7cm - 1.4"x2.8"  
wide spacing



- Highlife III**  
Wood size 4x4/8/16 cm - 1.6"x1.6"/3.2"/6.3"  
with narrow spacing



## Warm CorTen Steel

Corten steel is the perfect material to use in public space with its natural properties, durability and low maintenance, warm colour and high environmental qualities adding to the attractiveness of natural and urban surroundings.

CorTen steel can be applied outdoors without any unfriendly treatment such as zinc or chemical coatings. CorTen is a steel alloy with added chromium, copper and nickel on which a dense patina of rust will appear. It takes 1 to 3 years before corrosion stabilizes. Streetlife supplies various products in CorTen steel. Apart from its warm appearance, CorTen steel has a number of advantages: it is environmentally friendly, graffiti and sticker-resistant, shows an attractive fading effect from orange to brown and due to its natural oxidation, any repairs or alterations to a CorTen steel structure will become invisible in time.



## All Black

Rough&Ready All Black benches are available in the same dimensions (7x15cm - 2.4x5.9) as our FSC® hardwood benches. The entire Rough&Ready product range is available in environmentally-friendly All Black beams. The beams measure 7 x 15cm across, wood size 3: The Rough & Ready Range.

This durable material is maintenance-free, has a coarse structure and does not splinter or crack. Ink and paint cannot penetrate the matt surface of the material. All Black is manufactured from locally-collected used plastic (like plastic bags, plastic used in construction and agriculture, plastic chairs, etc.), which is then recycled and dyed a black that retains its colour throughout the structure of the beam. The colour is created using a polyethylene and polypropylene compound that remains durably black due to a process of UV stabilisation. Some air inclusions at the beam ends are unavoidable.



## Cloudy Grey

As an alternative to FSC® hardwood, Streetlife introduces the exceptionally hard-wearing Cloudy Grey beams measuring 7x7cm. Wood size 4; the Solid Series. This material is 50% recycled LDPE plastic combined with 50% recycled textile fibres and remnants. The beams are a maximum of 120cm in length.

The textile waste mountain is an even bigger environmental issue than the plastic waste mountain but using Cloudy Grey beams means that these materials are recycled and given a new use! The grey marbled appearance has its own unique character. Its technical properties make Cloudy Grey an attractive and fully-fledged alternative to wood. Some air inclusions at the beam ends are unavoidable.





Index

Category 1  
Rough Benches & Picnic Sets

- Rough&Ready
- Heavy-Heavy
- Drifter
- Stone



Rough&Ready Curved Benches  
14



Rough&Ready Royal Curved Benches  
16



Rough&Ready Circular Benches  
20



Rough&Ready Top Seats  
22



Rough&Ready 6 Benches  
24



Rough&Ready T6 Benches  
26



Rough&Ready 10 Benches  
28



Rough&Ready Crosswise Benches  
32



Rough&Ready Carré Benches  
34



Rough&Ready Cubes & Balancer  
36



Rough&Ready Lounge Seats & Loungers **NEW**  
38



Rough&Ready Picnic Sets  
42



Heavy-Heavy Block Seats **NEW**  
50



Heavy-Heavy Benches  
52



Heavy-Heavy Industry Benches **NEW**  
54



Heavy-Heavy Malaparte **NEW**  
56



Drifter Benches **NEW**  
58



Drifter Picnic Sets **NEW**  
62



Drifter Structures **NEW**  
64



Stone Benches  
66

NEW

No fewer than 34 new products have been added to the Streetlife Collection, including the contemporary Heavy-Heavy Block Seats. These sturdy Block Seats are available in your choice of W-Wood or FSC® Recycled Douglas.



Rough  
&  
Ready



The **Rough&Ready** product range holds a unique position within the Streetlife Collection. The products have a 'minimal' look and incorporate three principle themes: Street Furniture, Tree Products and Bridges & Decking.

- The coherence of the various R&R products is unprecedented, due in part to the use of a single, substantial modular wood size of 7x15cm. - 2.8"x5.9"
- Rough&Ready offers the architect a great deal of freedom in design.
- The Rough&Ready range is sturdy and robust, uses sustainable materials and affords a contemporary appearance.

In addition to the catalogue, the Rough&Ready product range is also set out in a separate brochure, which can be requested online!







Design: Peter Krouwel  
Protected by int. Model Depots and Patents

Rough&Ready Picnic set  
Rough&Ready Tree Planters  
Rough&Ready Tree Isles  
Rough&Ready Bicycle Parking

See also:

Streetlife Brochure 2018 - 2019

## Rough&Ready Curve Benches



**R&R-C-200-60**  
79"x24"x18" | 200x60x45cm



**R&R-C-200-60 + R&R-C-200-60-Ext + R&R-C-BR1-60**  
400x60x45cm | 157"x24"x18"



**R&R-C-200-60 + 2x R&R-C-200-60-Ext + 2x R&R-C-BR2-60**  
236"x24"x18" | 600x60x45cm



**R&R-C-200-60-AB + R&R-C-200-60-AB-Ext**  
400x60x45cm | 157"x24"x18"



**R&R-C-200-60 + 3x R&R-C-200-60-Ext + R&R-C-RBR-400**  
315"x24"x18" | 800x60x45cm

With their curved shape, **Rough&Ready Curve Benches** have a distinctive appearance. These benches consist of transverse modular beams mounted in a self-supporting Streetlock® comb. The 200cm-long modules can be linked together to create any desired length. Arm and backrests are available as optional add-ons. Backrests consist of a rounded back element that can be mounted almost anywhere on the bench. The transverse positioning of the beams make R&R Curve Benches highly unappealing to skateboarders.

Standard bench 200cm x 40/50/60cm - 78"x16"/20"/24"  
Beams 7x15cm - 2.8"x5.9", in galvanized-, coated or CorTen steel.  
Material FSC® hardwood or recycled 'All Black'  
Outer radius approx. 800 cm - approx. 314"

Three types of backrests can be mounted on the Rough&Ready Curve Benches, both on the curved inside and on the outside.

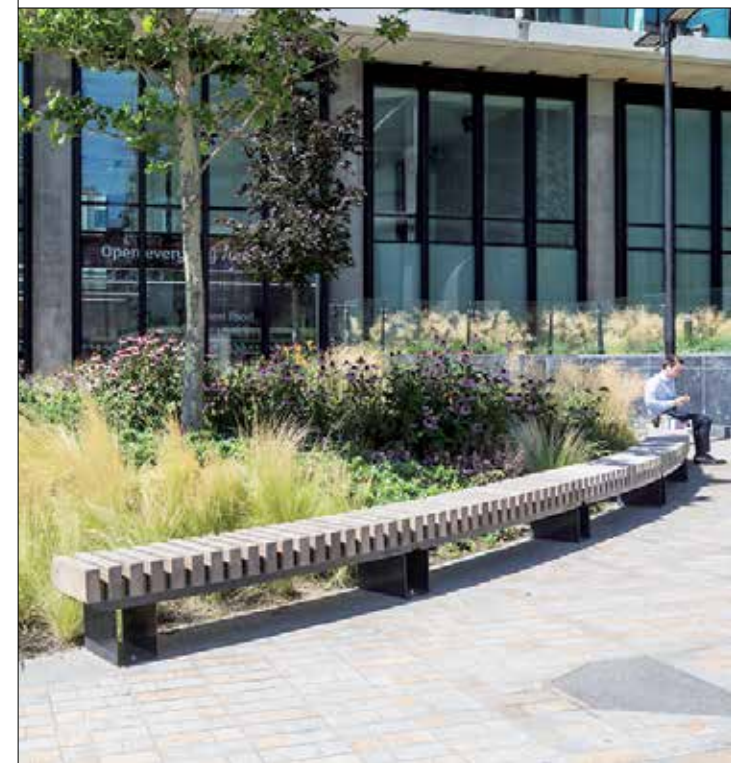

Rough&Ready Curve Benches possess distinct character. These curved benches are ideal for creating a long, curved seating or serpentine configuration that allow landscape and bench to become a perfect match.





# Rough&Ready Royal Curve Benches

**Rough&Ready Royal Curve Benches** are characterized by a high backrest, which provides additional comfort and style. The seating element consists of the R&R Curve Bench and the Royal Back Backrest back element.

Royal Back modules are available in standard 2-metre-long segments. The beams of the backrest correspond to the beams of the bench when mounted. The modular segments are often linked together to create a closed or continuous backrest.

The Royal Back Backrest can also be used with both our R&R Circular Bench series as well as our R&R Crosswise Bench series.



**R&R-C-RBR-200**  
Convex



**R&R-C-RBR-200**  
Concave

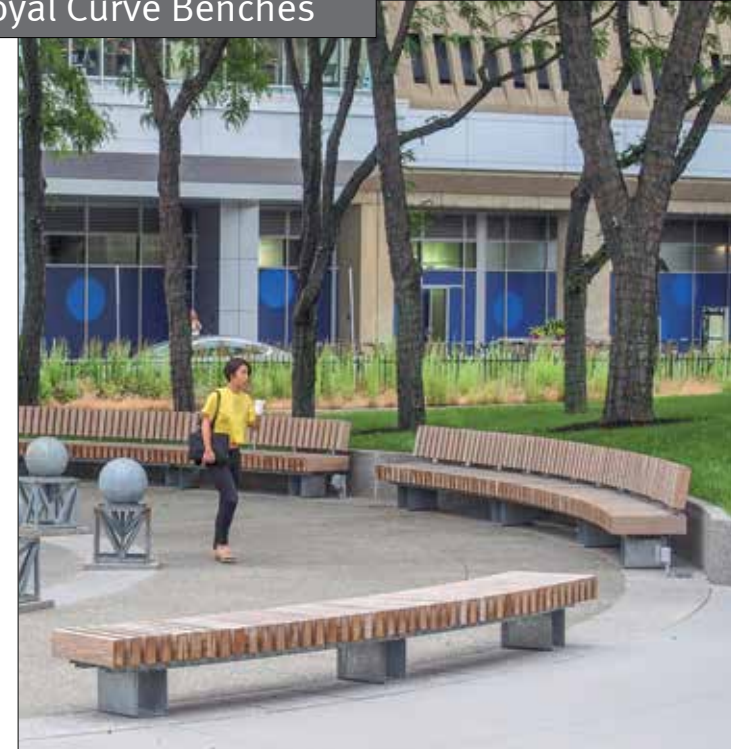

Design: Streetlife  
Protected by int. Model/Depots and Patents

Rough&Ready Picnic set  
Rough&Ready Tree Planters  
Rough&Ready Tree Isles  
Rough&Ready Bicycle Parking

See also:

Streetlife Brochure 2018 - 2019









Design: Peter Krouwel  
Protected by int. Model Depots and Patents

Rough&Ready Picnic set  
Rough&Ready Tree Planters  
Rough&Ready Tree Isles  
Rough&Ready Bicycle Parking

Streetlife Brochure 2018 - 2019

## Rough&Ready Circular Benches



**R&R-CI-R150**  
940x40x45cm | 370"x16"x18"



**R&R-CI-R200 + 2x R&R-C-LBR-60**  
1255x50x45cm | 494"x20"x18"

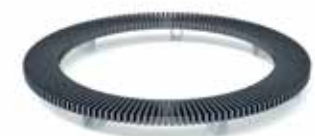

**R&R-CI-R250-AB**  
1570x60x45cm | 618"x24"x18"



**R&R-CI-R300 + SR**  
1885x60x45cm  
742"x24"x18"



**R&R-CI-R350 + R&R-C-RBR-200**  
2200x60x45cm | 866"x24"x18"



**R&R-CI-R400**  
2510x60x45cm  
988"x24"x18"

Monumental urban trees call for a generous circular bench with well-protected growing space. The benches are available in 6 dimensions.

The backrests are optional. The supports and curved frame are made of thermo-galvanized, coated or CorTen steel. The **circular benches** are made of 100% FSC® untreated hardwood. They are also available with All Black beams, made out of recycled black plastic.

An optional 'Second Row' (SR) is available, providing raised seating.

R&R Curve	R150	R200	R250	R300	R350	R400
Outer diameter	3 m	4 m	5 m	6 m	7 m	8 m
Inner diameter	2,2 m	3 m	3,8 m	4,8 m	5,8 m	6,8 m
Seat length	± 9 m	± 12 m	± 15 m	± 18 m	± 21 m	± 24 m
Seat length Second Row	-	-	-	± 15 m	± 18 m	± 21 m
Sitting depth	40 cm	50 cm	60 cm	60 cm	60 cm	60 cm
Sitting height	45 cm	45 cm	45 cm	45 cm	45 cm	45 cm
Number of supports	5	6	7	9	10	12



A magnificent monumental tree is further enhanced when it's framed whether in a city centre or a park. By installing the timeless Circular Bench, both the urban tree as well as the growing space can be attractively protected, as has been the case in Veghel (NL).



# Rough&Ready Top Seats





**R&R-CW-TOP-200-50**  
200x50x17cm  
79"x20"x7"



**R&R-C-TOP-200-50-AB**  
200x50x17cm | 79"x20"x7"



**R&R-C-TOP-Custom**



**R&R-L5-TOP-234**  
234x49x17 cm | 92"x19"x7"



**R&R-L6-TOP-300**  
300x59x17 cm  
118"x23"x7"



**R&R-L10-TOP-300**  
300x100x17cm | 118"x39"x7"

Design: Peter Krouwel  
Protected by int. Model Depots and Patents

Streetlife Brochure 2018 - 2019

# Rough&Ready Top Seats

The **Rough&Ready Top Seats** are loose seats that can be mounted on a stone, brick or concrete wall of approx. 30cm - 12" high. The FSC® hardwood beams are robust and locked into stainless- steel Streetlock® comb fittings, which are invisibly embedded in the wall or concrete block.

Three different models are available:

- The R&R 5, 6 or 10 Topseats (long, straight seats)  
Length: 234cm or 300cm - 92" or 118"
- The R&R Curve Topseats (curved or circular configurations):  
Length: modules of 200cm - 7ft  
Width: 50, 60 and 100cm - 20", 24" or 39"
- The R&R Between Seats with an extremely robust frame.  
Length: modules of 200cm - 7ft  
Width: 60cm - 24"



Design: Peter Krouwel  
Protected by int. Model Depots and Patents

Rough&Ready Picnic set  
Rough&Ready Tree Planters  
Rough&Ready Tree Isles  
Rough&Ready Bicycle Parking

See also:

Streetlife Brochure 2018 - 2019





R&R Between Seats between Shrubtubs tree planters



**R&R-C-BTS-200-60**  
200x60x17  
118"x24"x7"



**R&R-CW-BTS-200-60**  
200x60x17  
118"x24"x7"



# Rough&Ready 6 Benches



**R&R-L6-250-AB**  
250x59x45cm  
98"x23"x18"



**R&R-L6-234-CT + R&R-L-BR1-154**  
234x59x45cm | 92"x23"x18"



**R&R-L6-300 + R&R-L-BR1-154**  
300x59x45cm  
118"x23"x18"



**R&R-L6-300 + 2x R&R-L6-300-EXT**  
900x59x45cm | 354"x23"x18"



**R&R-L6-300 + R&R-L6-300-Ext + 2x R&R-L-HBR-234**  
600x59x45cm  
236"x23"x18"

Design: Peter Krouwel  
Protected by int. Model Depots and Patents

Streetlife Brochure 2018 - 2019

# Rough&Ready 6 Benches

The **Rough&Ready 6 Benches** are sturdy and robust. The beams made of durable FSC® hardwood are 15cm - 5.9" thick. They are fixed to the supports by means of our stainless steel and theft-proof Streetlock® comb system. The Streetlock® system affords the benches an extremely long lifespan because the beams can be turned over after 10 to 12 years. The optional backrest is convexly planed and can be fixed at various positions along the length of the bench.

R&R-6 bench of 6 FSC® hardwooden beams with rectangular supports which can be linked to create endless linear arrangements. In addition to the standard length of 234cm - 92", extra-long 300cm - 118" benches are available. All Black benches are available in lengths of 200cm and 250cm - 79" and 98". Some air inclusions at the beam heads are unavoidable.



The R&R 6 Benches are available with a low backrest which gives comfortable support to the lower back. The high backrest with comfortably rounded off beams is positioned asymmetrically. In combination with stainless steel armrests, this bench can be modularly adapted to suit many different local regulations.



**ARM-L-ST**



**R&R-L-BR1-154**



**R&R-L-BR2-154**

Design: Peter Krouwel  
Protected by int. Model Depots and Patents

Rough&Ready Picnic set  
Rough&Ready Tree Planters  
Rough&Ready Tree Isles  
Rough&Ready Bicycle Parking

See also:

Streetlife Brochure 2018 - 2019





## Rough&Ready T6 Benches

The **Rough&Ready T6 Benches** have been developed especially for Scandinavia and Canada, where in winter it gets dark quite early. The support bearer is placed longitudinally and is made of galvanized sheet steel. R&R backrest elements and armrests are easy to install.

The bearer can be easily opened to mount the support to the surface and offers sufficient space for a local electrician to install terminal boxes, for the optional LED lighting. The FSC® hardwood beams (7x15cm - 2.8"x5.9") are embedded in stainless steel Streetlock® combs. The robust beams are fitted with two sets of bars and anti-theft flange nuts. The Streetlock® system affords the benches an extremely long lifespan because the beams can be turned over after 10 to 12 years.

On both sides of the support bearer, two beams are fitted with a slot at the underside to accommodate an optional LED light strip. When dark, the LED light will completely illuminate the vertical support bearer, giving the bench a graceful, floating appearance.



**R&R-T6-600**  
600x59x45cm | 236"x23"x18"



**R&R-T6-234 + R&R-T6-LED**  
234x59x45cm  
92"x23"x18"

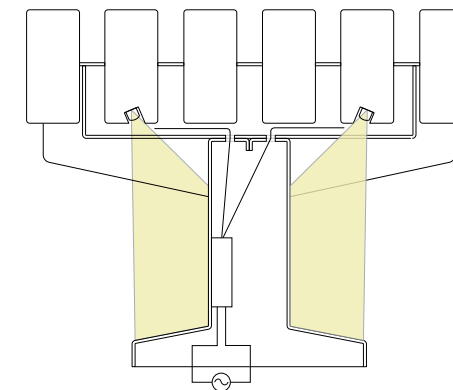

Cross-section of an R&R T6 Bench.

Design: Streetlife  
Protected by int. Model Depots and Patents

Rough&Ready Picnic set  
Rough&Ready Tree Planters  
Rough&Ready Tree Isles  
Rough&Ready Bicycle Parking  
See also:

Streetlife Brochure 2018 - 2019





The R&R 10 benches are ideal for two-sided use with the addition of the comfortable high backrest, as seen here in Kinderdijk in the Netherlands.

Design: Peter Krouwel  
Protected by int. Model Depots and Patents

Rough&Ready Picnic set  
Rough&Ready Tree Planters  
Rough&Ready Tree Isles  
Rough&Ready Bicycle Parking

See also:

Streetlife Brochure 2018 - 2019

## Rough&Ready 10 Benches



**R&R-L10-234**  
234x100x45cm  
92"x39"x18"



**R&R-L10-250-AB**  
250x100x45cm | 98"x39"x18"



**R&R-L10-300**  
300x100x45cm  
118"x39"x18"



**R&R-L10-300 + 2x R&R-L10-300-Ext**  
900x100x45cm | 354"x39"x18"

**Rough&Ready 10 Benches** is constructed with ten robust beams (7x15cm - 2.8"x5.9") fitted with the Streetlock® system. The benches form a spacious, double-sided seating area (approximate width 100cm - 39") and are available in lengths of 234cm and 300cm - 92" and 118". They can be linked together endlessly. Single and double backrests and armrests are easy to install.



**ARM-T-ST**



**R&R-L-BR1-154**



**R&R-L-BR2-154**







## Rough&Ready Seat Wall

**Rough&Ready Seat Walls** are available as detached benches or mounted against a tree or shrub tub, or other plant products. The continuous base structure is usually made of CorTen steel. R&R beams are then attached to this frame with recessed mounts in the CorTen steel plate. Because the FSC® hardwood beams (60cm - 24") are mounted transversely, they act as a natural deterrent against skateboarders. The StreetLock® system makes them easy to replace. R&R backrest elements and armrests are easy to install. Both the straight and curved Seat Walls models generally require customisation.



Rough&Ready Picnic set  
 Rough&Ready Tree Planters  
 Rough&Ready Tree Isles  
 Rough&Ready Bicycle Parking

See also:

Streetlife Brochure 2018 - 2019

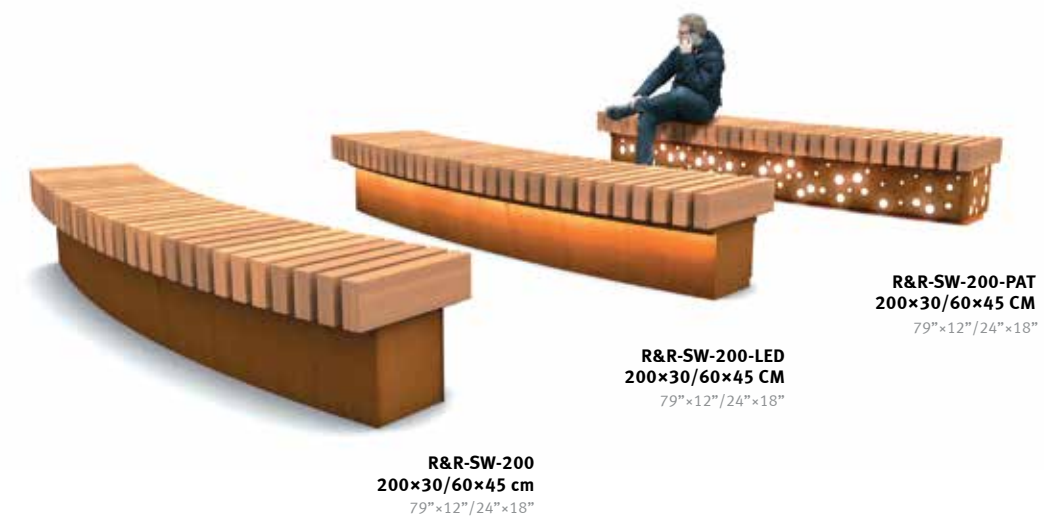

### LED-ready (optional)

A basic LED-ready solution is achieved by fitting an LED-strip in a mounting recess on the underside of two R&R beams. This illuminates the entire support frame. A second LED-ready solution is achieved by fitting LED elements behind the CorTen Seat Wall perforated with a pattern (such as Casual Dots). This creates a romantic playful effect once the sun goes down.





Design: Streetlife  
Protected by int. Model Depots and Patents

Rough&Ready Picnic set  
Rough&Ready Tree Planters  
Rough&Ready Tree Isles  
Rough&Ready Bicycle Parking

See also:

Streetlife Brochure 2018 - 2019

## Rough&Ready Crosswise Benches

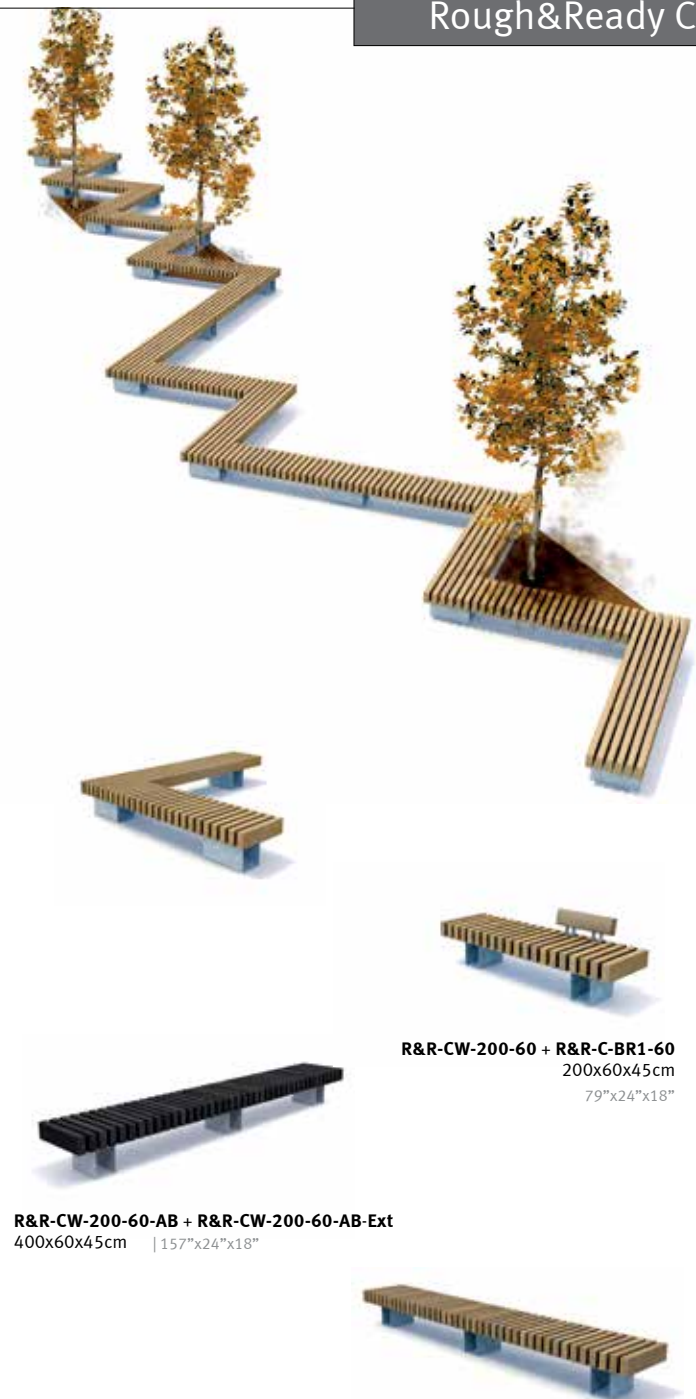

**Rough&Ready Crosswise Benches** are straight benches on which robust beams (7x15cm - 2.8"x5.9") are laid crosswise. The R&R beams have a depth of 60cm - 24" and are embedded in a support rail with Streetlock® comb. Due to the crosswise positioning of the beams, a natural anti-skate solution is created. The R&R Crosswise Benches can be beautifully combined with the R&R 6 Benches or R&R Curve Benches. Low, high and Royal backrest elements as well as the universal armrest can be optionally mounted.

By combining R&R Crosswise Benches with straight benches, a wide variety of playful and surprising configurations can be created. Whether standing alone or in combination with trees, the module can be used to create an angular and irregular configuration, as shown in the image.

Just like the entire Rough&Ready Range, these benches are also available in All Black.

**R&R-CW-200-60 + R&R-C-BR1-60**  
200x60x45cm  
79"x24"x18"

**R&R-CW-200-60-AB + R&R-CW-200-60-AB-Ext**  
400x60x45cm | 157"x24"x18"

**R&R-CW-200-60 + R&R-CW-200-60-Ext**  
400x60x45cm  
157"x24"x18"



Rough&Ready Crosswise Benches are fitted with repeating, transverse R&R beams that not only provide them with a minimalist design look, but also offer a natural deterrent against skateboarders. Photo: Baltimore.





Design: Streetlife  
Protected by Int. Model Depots and Patents

Rough&Ready Picnic set  
Rough&Ready Tree Planters  
Rough&Ready Tree Isles  
Rough&Ready Bicycle Parking

Streetlife Brochure 2018 - 2019

## Rough&Ready Carré Benches



**TGR-S150-PC + R&R-CAR-180-CT + R&R-L-BR1-154**  
71"x68"x18" | 180X173X45 cm



**TGR-S120-CT + R&R-CAR-150-CT**  
150X142X45 cm | 59"x56"x18"



**R&R-CAR-210-CT + R&R-L-BR1-154**  
83"x81"x18" | 210X205X45 cm



**R&R-CAR-180-PC + R&R-L-BR1-154**  
180X173X45 cm | 71"x68"x18"

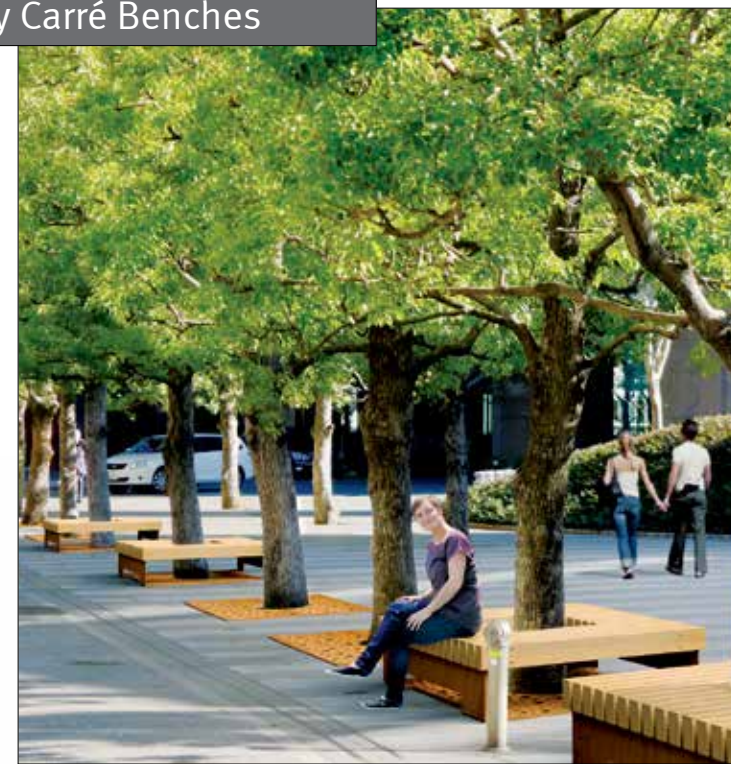

**Rough&Ready Carré Benches** specially facilitate areas with existing and new trees. They are square benches with a square hole in the centre for the accommodation of a tree. The FSC® hardwood beams (7x15cm - 2.8"x5.9") are integrated with a CorTen steel structure and attached by means of the Streetlock® system. R&R Carré Benches can be beautifully situated around urban trees.

R&R Carré Benches are optionally available with a matching CorTen Tree Grid, as shown in the images. The steel can be optionally coated in a RAL colour.

Available sizes 150x150cm, 180x180cm and 210x210cm  
59"x59", 71"x71" and 82"x82"

R&R backrest elements and armrests are easy to install.





This square in the Ledeborg district of Ghent in Belgium has been refurbished as part of a neighbourhood renewal project. Various R&R CorTen Tree Isles and R&R Cubes have been placed around the district.

Design: Streetlife  
Protected by Int. Model Depots and Patents

Rough&Ready Picnic set  
Rough&Ready Tree Planters  
Rough&Ready Tree Isles  
Rough&Ready Bicycle Parking

See also:

Streetlife Brochure 2018 - 2019

## Rough&Ready Cubes & Balancer

The compact **Rough&Ready Cubes** are robust square benches available in 60x60cm and 100x100cm - 24"x24" and 39"x39". They are the perfect way to create small seating areas in combination with other R&R products. The R&R beams are mounted using the StreetLock® system.

The **Rough&Ready Balancer** is a playful bench with a central support made from a heavy gauge steel plate (CorTen or galvanized steel). The support can be mounted into a concrete slab for paved areas. For grassy areas, the support can also be mounted on a concrete slab placed underground.



**R&R-L6-CUB**  
60x59x45cm  
24"x23"x18"



**R&R-L10-CUB-AB**  
100x100x45cm  
39"x39"x18"



**R&R-L6-BAL-GM**  
200x59x45cm  
79"x23"x18"



**R&R-L6-BAL-CT**  
200x59x45cm  
79"x23"x18"





## Rough&Ready Lounge Seats

NEW

The **Rough&Ready Lounge Seats** are part of the extensive Rough&Ready Range, which uses one single modular wood size measuring 7x15cm - 2.8"x5.9". These comfortable seats can be placed on their own or arranged in a row. The smart and sturdy joint between the high back and the seat is a striking detail. The beams are made of FSC® hardwood. The supports are hot-dip galvanized, powder coated or CorTen steel. The 6-slat seat is 57cm - 22" wide and the 14-slat seat is 137cm - 54" wide.



**R&R-LS-140-CT**  
137x47/75x45/90cm  
54"x19/30"x18"/35"



**R&R-LS-60-CT**  
57x47/75x45/90cm  
22"x19/30"x18"/35"



Design: Streetlife  
Protected by Int. Model Depots and Patents

Rough&Ready Picnic set  
Rough&Ready Tree Planters  
Rough&Ready Tree Isles  
Rough&Ready Bicycle Parking

See also:

Streetlife Brochure 2018 - 2019





The robust R&R Loungers are perfect for leisure areas like the Shelby Farms Park, one of America's largest urban parks. As Streetlife was included in the design process of James Corner Field Operations, it was possible to adapt some of the Streetlife products to a bespoke fit in the park.

## Rough&Ready Loungers

The sturdy **Rough&Ready Loungers** are perfect for relaxing in the sun. The R&R beams are mounted using the StreetLock® comb system. R&R Loungers even look great from the back thanks to their innovative construction. They are available in two models: XL and XXL. The Loungers are the result of a collaborative effort with James Corner Field Operations, New York.

Dimensions XL L=180cm - 71", B=70cm - 28"  
 Dimensions XXL L=230cm - 91", B=90cm - 35"

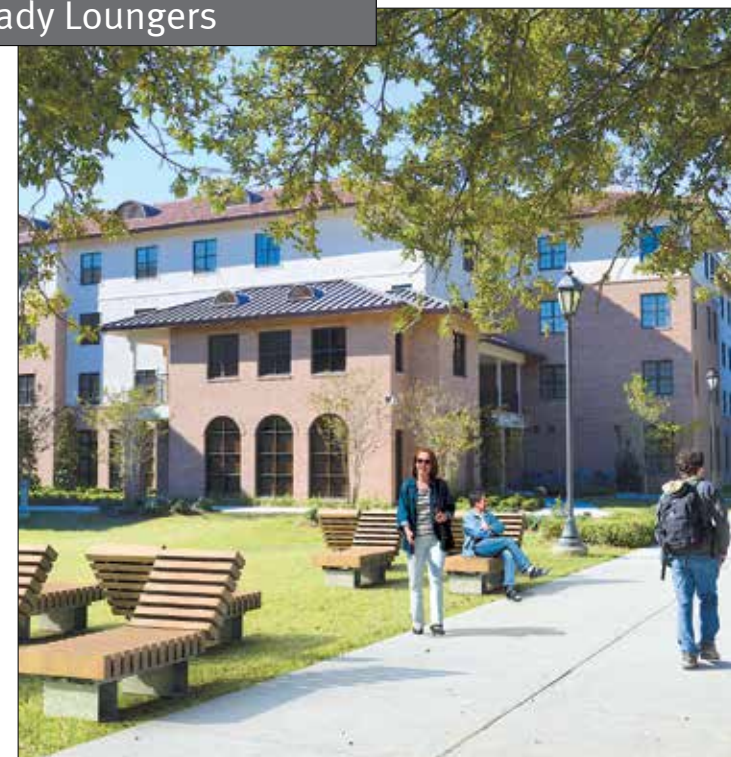

**R&R-LNG-230**  
 230x90x45/116cm  
 91"x35"x18/46"



**R&R-LNG-180**  
 180x70x45/100cm  
 70"x28"x18/39"

Design: James Corner Field Operations  
 Protected by int. Model Depots and Patents

Rough&Ready Picnic set  
 Rough&Ready Tree Planters  
 Rough&Ready Tree Isles  
 Rough&Ready Bicycle Parking

See also:

Streetlife Brochure 2018 - 2019





Thanks to the combination of All Black beams with galvanized steel, these Rough&Ready Picnic Sets are extremely durable, low-maintenance landscaping elements.  
Photo: Malmö, Sweden.

Design: Streetlife  
Protected by Int. Model Depots and Patents

Rough&Ready Benches  
Rough&Ready Tree Planters  
Rough&Ready Tree Isles  
Rough&Ready Bicycle Parking

See also:

Streetlife Brochure 2018 - 2019

## Rough&Ready Picnic Set



**R&R-PS-234-CT**  
234x187x45/83 cm  
92"x74"x18/33"



**R&R-PS-200-TH-AB**  
200x187x45/83 cm  
79"x74"x18/33"



**R&R-PS-300-PC**  
300x187x45/83 cm  
118"x74"x18/33"



**R&R-PS-300-TH-AW**  
300x187x45/83 cm  
118"x74"x18/33"

The **Rough&Ready Picnic Set** extends the robust, industrial range to providing social areas and workspaces. The set combines flawlessly with other R&R products. The picnic table top is made of FSC®-100% hardwood beams (7x15cm- 2.8"x5.9") with a flat, integrated steel mid-section. Available in various materials: CorTen steel, hot-dip, galvanized steel or powder-coated in a RAL colour.

Lengths: 234cm and 300cm - 92" and 118"  
Length in All Black: 200cm - 79"







PEER GYNT  
HOTEL & SPISERI

PEER GYNT  
HOTEL & SPISERI





Design: Streetlife  
Protected by int. Model Depots and Patents

Rough&Ready Picnic set  
Rough&Ready Tree Planters  
Rough&Ready Tree Isles  
Rough&Ready Bicycle Parking

See also:

Streetlife Brochure 2018 - 2019

## Rough&Ready All Black

**Rough&Ready All Black** benches are available in the same dimensions (7x15cm - 2.8"x5.9") as our FSC® hardwood benches. The entire Rough&Ready product range is available in environmentally-friendly All Black beams.

This durable material is maintenance-free, has a coarse structure and does not splinter or crack. Ink and paint cannot penetrate the matt surface of the material.

All Black is manufactured from locally-collected used plastic (like plastic bags, plastic used in construction and agriculture, plastic chairs, etc.), which is then recycled and dyed a black that retains its colour throughout the structure of the beam. The colour is created using a polyethylene and polypropylene compound that remains durably black due to a process of UV stabilisation.



A playground fitted with All Black circular benches in Stockholm. The All Black goes well with the colourful rubber surface used in many playgrounds. Other good reasons to opt for All Black are that it never splinters or cracks unlike wood and that it is fully made out of recycled materials.

Streetlife used All Black to create an attractive 120-metre-long - 393ft Curve Bench along the banks of Vättern Lake in Atollen, Jönköping, Sweden. R&R Topseats with a depth of 90cm were placed on a locally manufactured concrete console. The bench meanders along the lake shore and makes for inviting seating from which to enjoy the weather and the view.





# Rough&Ready All Black

Design: Streetlife  
Protected by Int. Model Depots and Patents

Rough&Ready Picnic set  
Rough&Ready Tree Planters  
Rough&Ready Tree Isles  
Rough&Ready Bicycle Parking

See also:

Streetlife Brochure 2018 - 2019



**R&R-BP-Beam-234-AB + 3x R&R-BP-Post-TH**  
234x7x75 cm | 92"x3"x30"



**R&R-C-200-50-AB + R&R-C-200-50-AB-Ext + R&R-C-BR1-60-AB**  
157"x20"x18" | 400x50x45cm



**R&R-CI-R250-AB**  
1500x60x45 cm | 591"x24"x18"



**R&R-C-TOP-Custom-AB**



**R&R-L6-250-AB**  
250x59x45 cm | 98"x23"x18"



**R&R-PL-Basic-S150-90-AB**  
59"x59"x35" | 150x150x90 cm



**R&R-L10-CUB-AB**  
100x100x45 cm | 39"x39"x18"

The Rough&Ready beams which are made of re-used synthetic material (old plastic bags, agricultural plastic sheeting, etc.) are black through and through: All Black. This sustainable material requires no maintenance and has a coarse texture. Ink and paint cannot penetrate the surface and will hardly adhere. The contrast between black beams and stainless-steel theft-proof nuts help the R&R benches designs to stand out against their natural background and create an even more striking appearance. The black material is a compound of re-used synthetic materials (PE and PP). They remain black due to the UV-stabilization process they have undergone. In contrast to wood, no maintenance is needed. The material does not discolour, is extremely durable and is extremely environment-friendly (no additives except black soot). Some air inclusions at the beam heads are unavoidable.

Lengths 200cm and 250cm - 79" and 98"  
Fire Class 3 according to NEN 6065







# Heavy-Heavy Block Seats

**NEW**

**Heavy-Heavy Block Seats** can be used to create all sorts of configurations. The Heavy-Heavy beams of 14x21cm - 5.5"x8.2" in W-Wood, or optionally in FSC® Recycled Douglas wood, are mounted on heavy gauge sheet steel supports with slanting lines. The Seats are ideally suited for campuses or schoolyards, either as individual Cubes or in a connected bench configuration.

The Heavy-Heavy Block Seats are available in both 3-slat (48cm -19" wide) and 5-slat (80cm - 31" wide) versions. With or without backrest.

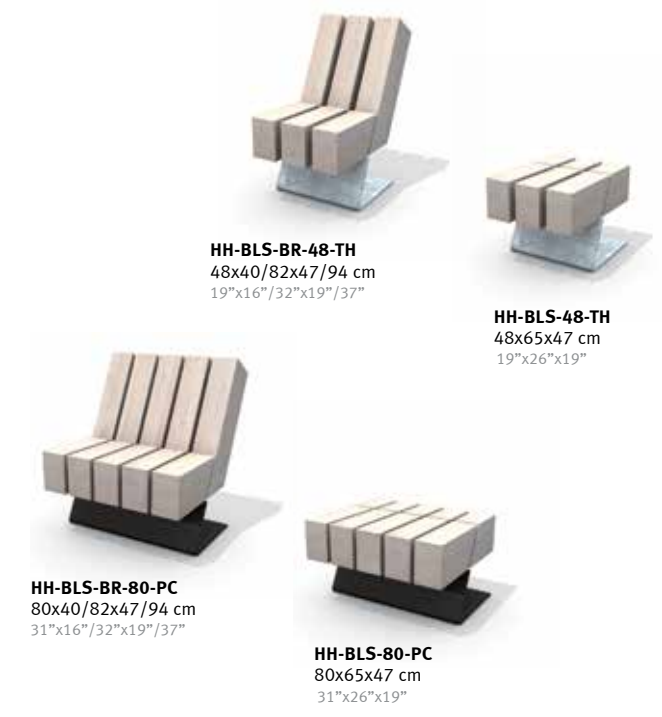
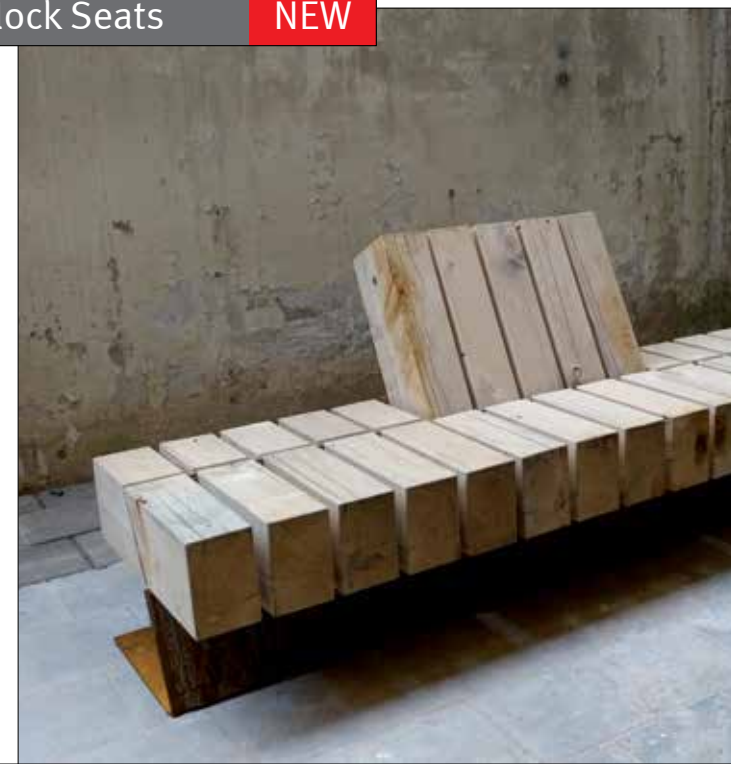

**HH-BLS-BR-48-TH**  
48x40/82x47/94 cm  
19"x16"/32"x19"/37"

**HH-BLS-48-TH**  
48x65x47 cm  
19"x26"x19"

**HH-BLS-BR-80-PC**  
80x40/82x47/94 cm  
31"x16"/32"x19"/37"

**HH-BLS-80-PC**  
80x65x47 cm  
31"x26"x19"

Design: Streetlife  
Protected by int. Model Depots and Patents

Streetlife Brochure 2018 - 2019





Design: Streetlife  
Protected by int. Model Depots and Patents

## Heavy-Heavy Benches



**HH-L3-BR2-325-PC**  
325x77x45/77 cm  
128"x30"x18"/30"



**2X HH-L3-BR1-325-CT**  
325x61+61x45/77 cm  
128"x24"+24"x18"/30"



**Heavy-Heavy Benches** are massive, heavy-duty benches created to reflect Streetlife's characteristic natural look. The heavy wooden beams are 14x21cm - 5.5"x8.2" in dimension and are available in three lengths: 225cm - 89", 275cm - 108" and 325cm - 128". The beams are secured on galvanized or CorTen steel cross-beam supports using the Streetlock® system.

The W-Wood® used in the Heavy-Heavy Benches is European FSC® pine made extremely durable through a process of deep treatment with a natural wax compound. The water-resistant properties of W-Wood® mean these benches are extremely long-lasting and are guaranteed to remain in top condition for the next 15 years. W-Wood® has a similar life expectancy to FSC® hardwood, but has a lower density and hardness. Just like hardwood, the polychrome honey brown will fade very gradually to a greyer tone (over a period of about 3 years).

The backrests are multifunctional and can be used as lean-supports, seating, table tops, etc. The backrests can be linked together just like the benches in order to create a longer piece.

The Heavy-Heavy Benches are characterised by the diagonal lines that run along their back and seats. The FSC® W-Wood® used in these benches has a similar life expectancy to FSC® hardwood, but has a lower density and hardness. The colour of the wood is polychrome brown.





Design: Streetlife  
Protected by int. Model Depots and Patents

Streetlife Brochure 2018 - 2019

## Heavy-Heavy Industry Benches NEW

**Heavy-Heavy Industry Benches** feature heavy wooden beams (W-Wood) measuring 14x21cm - 5.5"x8.2" and mounted on sturdy supports with an industrial appearance. The double stainless steel Streetlock® system extends the lifespan because the beams are easy to rotate, even after ten years. An attractive connecting support unit enables extra-long bench configurations.

The supports are made of hot-dip galvanized steel, CorTen or powder-coated steel.

The 3-, 4- and 5-slat benches come in Heavy-Heavy standard lengths of 225, 275 and 325cm, (89", 108", 128") etc.

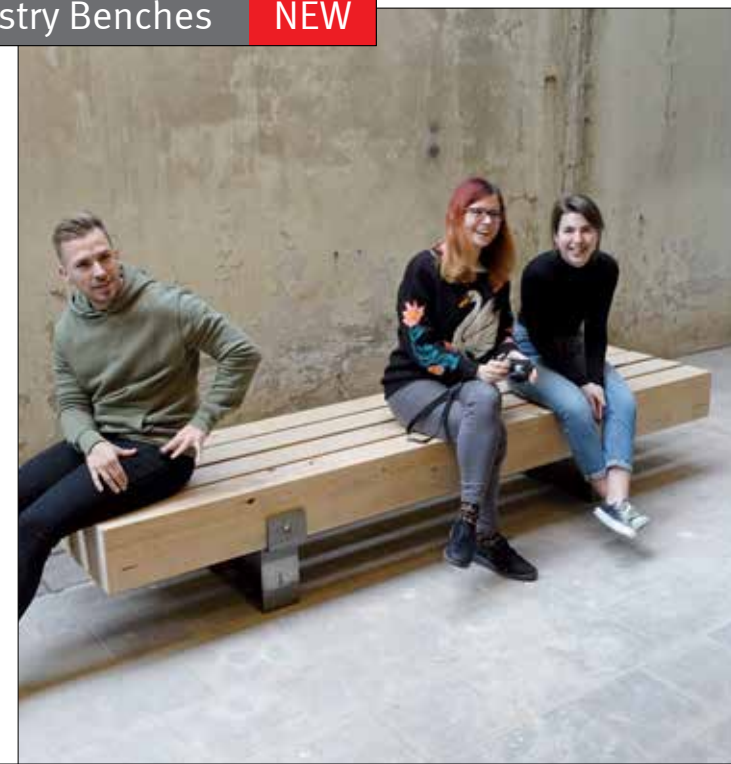





Design: Streetlife  
Protected by int. Model Depots and Patents

## Heavy-Heavy Malaparte

NEW

Villa **Malaparte** on the Italian island of Capri is a villa with a unique design at an incredible location. It inspired Streetlife to create bleachers in a trapezoid shape. The Heavy-Heavy beams measuring 14x21cm - 5.5"x8.2" (W-Wood) are mounted on a base of CorTen steel.

The raised seating creates a pleasant spot from which to enjoy the view. Dimensions: approx. 325cm long, height approx. 140cm.

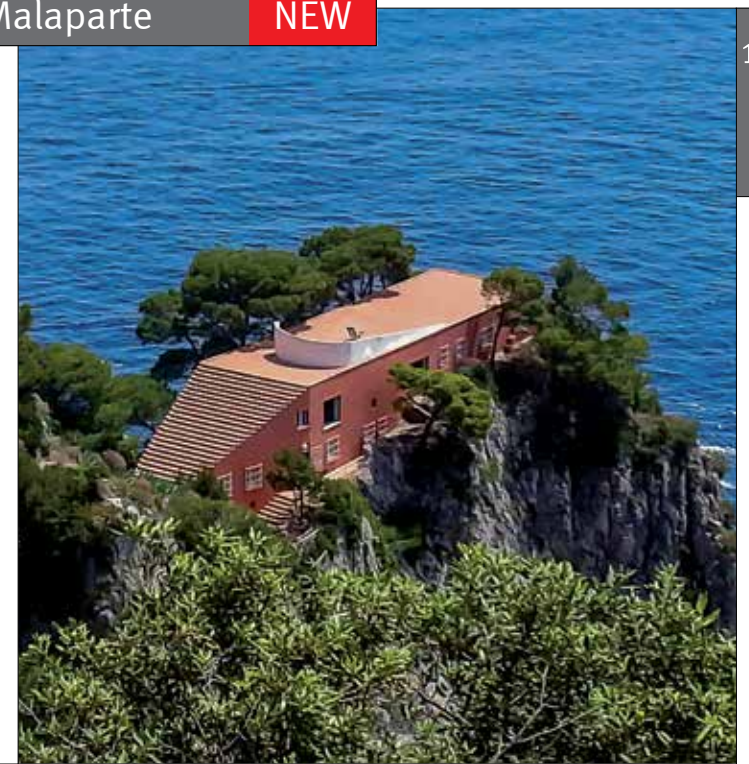

Streetlife Brochure 2018 - 2019







Design: Streetlife  
Protected by int. Model Depots and Patents

## Drifter Benches

The Drifter Benches are made of reclaimed mooring posts of 30x30cm -12"x12", recovered from local water infrastructure. The 30- to 40-year-old tropical hardwood is certified FSC® recycled wood. These benches are an example of the circular economy, with a unique rustic look that appeals to the imagination. There are Drifters Benches with one or two slats (L1/L2).

The extraordinary density of the tropical hardwood make the beams and the entire bench massively heavy. Because of the nature of the recycled material, deviations in size and irregularities cannot be avoided. The supports are made of heavy gauge CorTen or hot-dip galvanized steel.

Lengths: 120, 200, 300 and 500cm - 47", 79", 118" and 198"  
 Width: L1 30 cm - 12", L2 62 cm - 24"  
 Height: 47 cm - 19"

The backrest is available in two different lengths:  
 120 and 180cm - 47" and 71".







Design: Streetlife  
Protected by int. Model Depots and Patents

Streetlife Brochure 2018 - 2019

## Drifter Benches

NEW

The Drifter Benches are made of reclaimed mooring posts of 30x30cm - 12"x12", recovered from local water infrastructure. The 30- to 40-year-old tropical hardwood is certified FSC® recycled wood. These benches are an example of the circular economy, with a unique rustic look that appeals to the imagination. There are Drifters Benches with one or two slats (L1/L2).

The extraordinary density of the tropical hardwood make the beams and the entire bench massively heavy. Because of the nature of the recycled material, deviations in size and irregularities cannot be avoided. The supports are made of heavy gauge CorTen or hot-dip galvanized steel.

Lengths: 120, 200, 300 and 500cm - 47", 79", 118" and 198"  
 Width: **L1** 30 cm - 12", **L2** 62 cm - 24"  
 Height: 47 cm - 19"

The backrest is available in two different lengths:  
 120 and 180cm - 47" and 71".

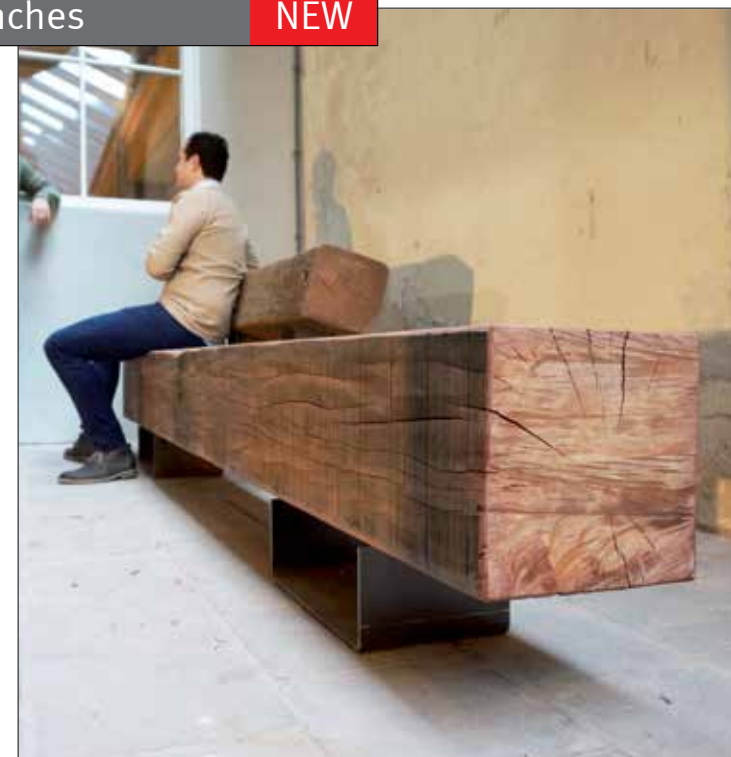





Design: Streetlife  
Protected by int. Model Depots and Patents

## Drifter Picnic Set

**NEW**

This extremely sturdy **Drifter Picnic Set** is made of reclaimed mooring posts. The 30- to 40-year-old tropical hardwood is certified FSC® recycled wood.

These enormous picnic tables are an example of circularity (second life, very long lifespan, and indestructible). The supports and brackets are made of CorTen or hot-dip galvanized steel.

Lengths available: 300, 400 and 500cm, 118", 157", 198".

The Drifter Range consists of benches, picnic sets and custom-made Drifter Structures.

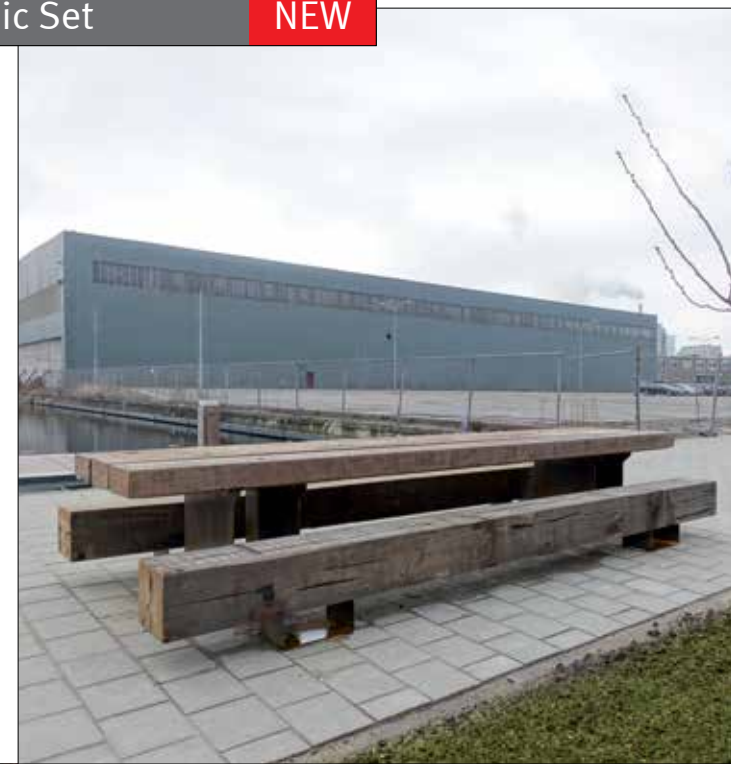

**DB-PS-L3-300-CT**  
300x62/168x47/85 cm  
118"x24/66"x19x33"



**DB-PT-L3-500-CT + DB-L1-400-CT + DB-L1-500-CT**  
500x62/168x47/85 cm  
197"x24/66"x19x33"





Design: Streetlife  
Protected by int. Model Depots and Patents

## Drifter Structures

NEW

The Drifter Range uses reclaimed mooring posts of approximately 30x30cm - 12"x12". The 30- to 40-year-old tropical hardwood is certified FSC® recycled wood. These beams can be used to create magnificent seating and bleachers. Streetlife is happy to assist with the development of these unique structures.

**Drifter Structures** make eye-catching additions to old industrial complexes and rugged harbour areas that are under redevelopment. The antique wood shows irregularities and scars.

Lengths available: a maximum of 5m -16ft per beam.

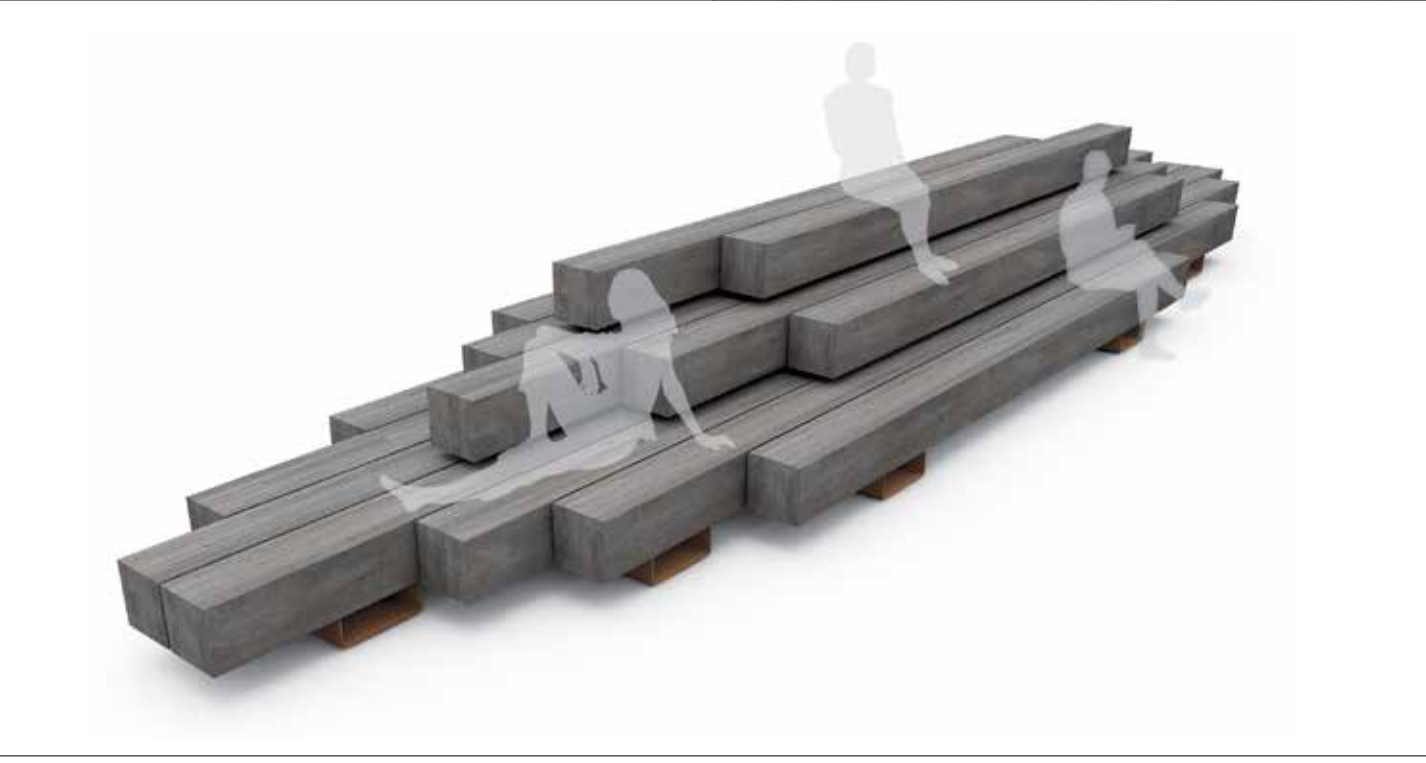
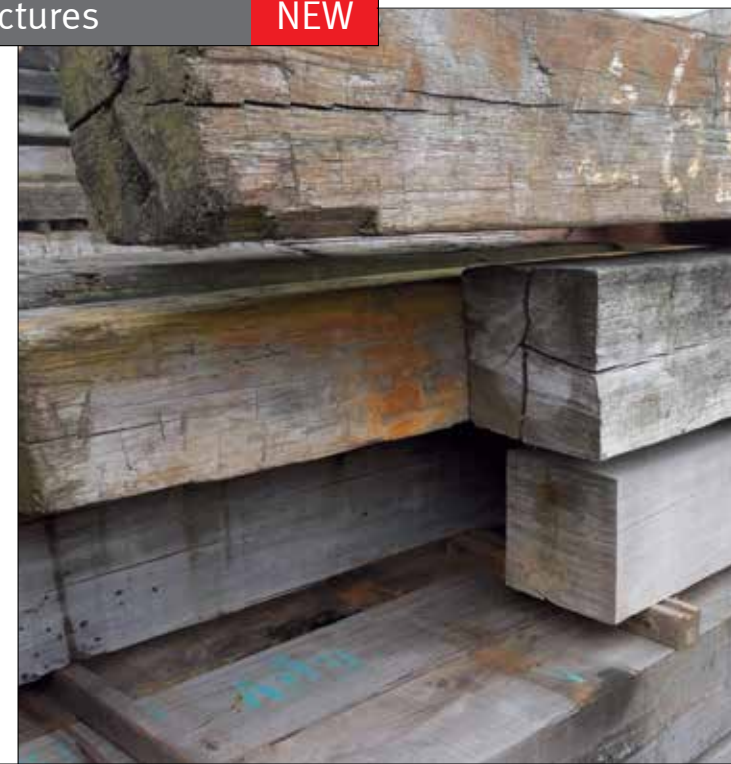





Design: Streetlife  
Protected by int. Model Depots and Patents

## Stone Bench Granito

Impressive in appearance, Streetlife's **Stone Benches Granito** can be placed in straight or curved configurations due to the shape of the granite tablets that form their seating element. The grey granite tablets are 12cm - 4.8" thick, 60cm - 24" wide and beautifully finished. They are also frost-resistant making them suitable for both indoor and outdoor use.

Both the straight as well as the Curve option can easily be linked together, giving architects the freedom to create a variety of configurations. Both the supports and base structure are available in galvanized or RAL-coated steel.

Length Starter Bench 180cm - 71", Extension Bench 150 cm - 59"  
Granite tablet weight approx. 42kg  
The Stone Bench Circle is available in three circular layouts, with external diameters of 330cm - 130", 390cm - 154" and 450cm - 177".







Design: Streetlife  
Protected by int. Model Depots and Patents

## Stone Benches Travertino

Impressive in appearance, Streetlife's **Stone Benches Travertino** can be placed in straight or curved configurations due to the shape of the granite tablets that form their seating element. In addition to the grey-coloured granite tablets, cream-coloured tablets are also available.

The Travertino tablets are not frost-resistant making them only suitable for indoor use or in a frost-free outdoor climate. The tablets are 12cm - 5" thick, 60cm - 24" wide and beautifully finished. Both the straight as well as the Curve option can easily be linked together, giving architects the freedom to create a variety of configurations. Both the supports and base structure are available in galvanized or RAL-coated steel.

Length Starter Bench 180cm - 71", Extension Bench 150 cm - 59"  
Granite tablet weight approx. 40kg







Solid 6 & 8 Benches  
74



Solid 12 Benches  
76



Solid Base Benches  
80



Solitude Benches  
82



Solid Love Benches  
84



Solid Staple Benches  
86



Solid Staple Picnic Sets **NEW**  
90



Solid Peano Benches **NEW**  
92



Solid X-Tables  
94



Solid Industry Picnic Sets **NEW**  
96



Solid Meet&Work  
98



Solid Picnic Sets  
100



Solid Seat Strips  
112



Cliffhanger Benches  
118



Olympic Wave Benches  
120



Olympic Wave Crosswise Benches  
122



Solid Serif Benches  
102



Solid Serif Benches  
102



Solid Serif Top Seats **NEW**  
103



Solid Serif Chaise Longue  
105



Wood Top System  
124



Long&Lean Benches  
126



The New Standard Bench **NEW**  
127



The Standard Picnic Sets  
128



Solid Skirt Benches  
106



Solid Skirt Benches  
107



Solid Skirt Top Seats **NEW**  
107



Solid San Marco Bench  
110



Horse Shoe Benches  
130



Highlife 3 Benches **NEW**  
132



Highlife 3 Top Seats **NEW**  
132



Highlife 3 picnic Sets **NEW**  
134

Category 2

**Fine Benches & Picnic Sets**

- Solid
- Highlife III
- Solitude
- Cliffhanger
- Long&Lean
- Olympic Wave
- Horse Shoe
- New Standard



## SOLID SERIES

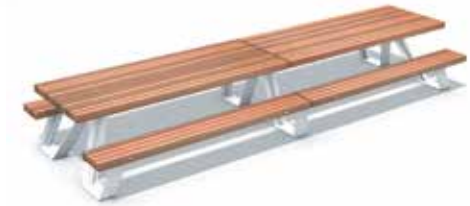
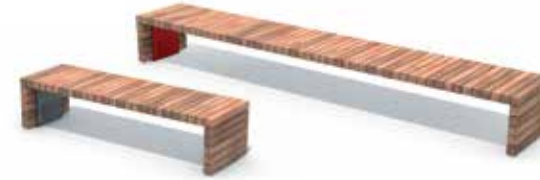

The products in the in **Solid Series** have a solid character. The product family includes benches, picnic tables, bicycle racks, podiums, tree planters, fencing and pedestrian and cycle bridges.

- The Solid identity is modest and minimal in terms of design.
- The steel support and structure are closed and therefore solid in their form.
- As a result of consistent detailing based upon the 7x7cm hardwood beams and their spacing, there is a strong interdependence between all the Solid products.







Design: Streetlife  
Protected by int. Model Depots and Patents

Solid Tree Planters  
Mobile Green Isles  
Solo Bridges  
See also:

Streetlife Brochure 2018 - 2019

## Solid 6 & 8 Benches



**SOL-L6-234**  
234x46x45cm | 92"x18"x18"



**SOL-L6-300**  
300x46x45cm  
118"x18"x18"



**SOL-L8-234 + SOL-L-QBR-180**  
234x62x45cm | 92"x24"x18"



**SOL-L8-200-AB**  
200x62x45cm  
79"x24"x18"



**SOL-L8-300**  
300x62x45cm | 118"x24"x18"

In terms of design, our **Solid 6 & 8 Benches** are modest and 'minimalistic'. Both the wooden seat and the steel supports have a closed (solid) character.

The FSC® hardwood 7x7cm - 2.8"x2.8" beams are mounted in Streetlock® comb fittings; the space between the slats is only 8mm - 0.3". The Solid slats are mounted with a rod and stainless-steel theft-proof flanged nuts. For maintenance or repairs, they can simply be replaced or turned over.

The steel supports are also solid in appearance, the closed steel support minimises the chance of waste accumulation. The supports can be easily anchored to the surface with concealed attachments. Optionally, they are available with an RAL coating. With the special connection units, long bench configurations can be realized. The two backrest models complement the Solid range.



These Solid 8 Benches grace the spectacular Malmö Live concert hall, congress centre and hotel in Sweden. The design of the Solid Benches fits harmoniously with the austere lines of Schmidt Hammer Lassen's architecture.





## Solid 12 Benches

**Solid 12 Benches** have a strongly understated design. Both the wooden seat and the steel supports have a sturdy look. The FSC® hardwood slats (7x7cm - 2.8"x2.8") are mounted into Streetlock® comb fittings. The gap width between slats is only 8mm - 0.3", giving the bench its closed (solid) appearance.

Streetlife makes two models of backrest that can be centrally mounted on the 12-slat approx. 90cm - 35" wide Solid Bench seat: the low Quattro Backrest made of 4 Solid slats or the convexly planed Soft Backrest. With its rounded shape, the Soft Back provides more comfortable back support compared to the Quattro Back. As a result, the Quattro Back is often seen more as a divider. In look and feel, both backrests reflect the minimalist design of the Solid Bench series.



**SOL-L-SBR-180**  
71" | 180 cm

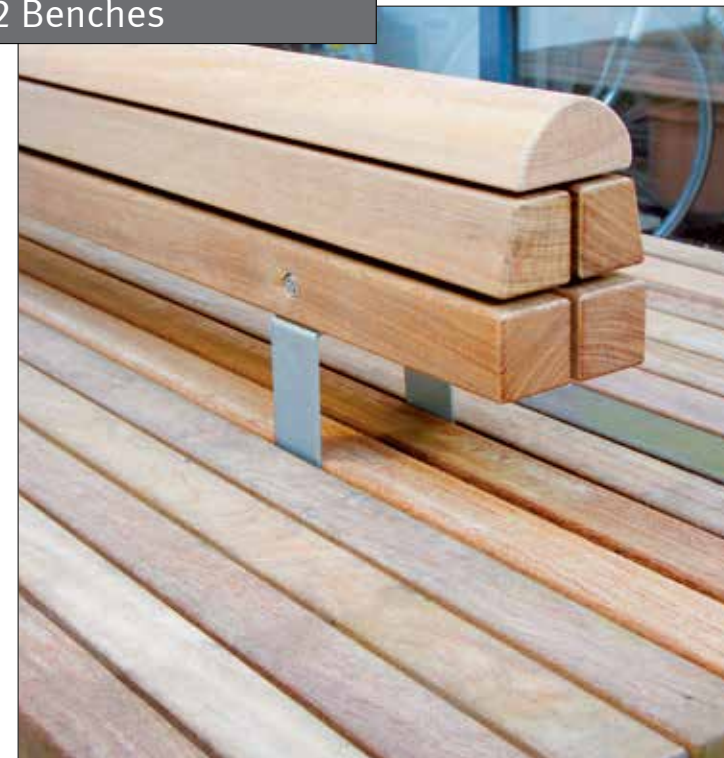

Solid Tree Planters  
Mobile Green Isles  
Solo Bridges

See also:

Streetlife Brochure 2018 - 2019



**SOL-L12-234 + SOL-L-SBR-180**  
234x92x45cm  
92"x36"x18"



**SOL-L12-300 + SOL-L12-300-Ext**  
300x92x45cm  
118"x36"x18"

These generously sized benches are an open invitation to enjoy a moment of peace and reflection in this historic setting at Huis Doorn in Doorn. The Solid 12 Bench fits perfectly with the new glass pavilion as well as the existing building and its wooded surroundings.









The bases of these Solid Base Benches in Zoetermeer, the Netherlands, are powder-coated in a subtle grey colour. The character of the Quatro Back backrest is a perfect fit with the rectangular form of the Base Benches.

Design: Streetlife  
Protected by int. Model Depots and Patents

Solid Tree Planters  
Mobile Green Isles  
Solo Bridges  
See also:

Streetlife Brochure 2018 - 2019

## Solid Base Benches

With the **Solid Base Benches** the 7x7cm - 2.8"x2.8" Solid slats are laid crosswise. The base construction is made of shot-blasted aluminium or galvanized steel. The attractive finish of the bases and their combination with warm, FSC® hardwood makes the benches suitable for making inconspicuous way finding arrangements in various configurations; available in square or elongated versions.



**SOL-L-QBR-180**  
180cm | 71"



**SOL-BAS-S120**  
120x120x45cm  
47"x47"x18"



**SOL-BAS-180-75-CT**  
180x75x45cm  
71"x30"x18"

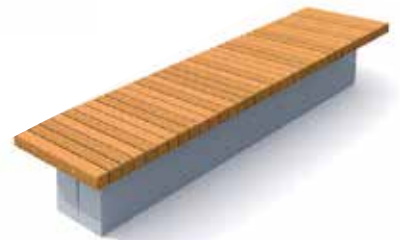

**SOL-BAS-270-75**  
270x75x45cm  
106"x30"x18"





## Solitude Benches

The **Solitude Bench** is a streamlined bench with an optional short, curving backrest. The high backrest is pleasantly comfortable. Solitude Benches are beautifully detailed and ideal for architectural gardens. If desired, the benches can be anchored to the surface with concealed attachments. The backrest makes for an exciting shape and the ergonomic support is truly superb.

The supports are available in CorTen steel or shot-blasted aluminium and are rounded on the inside. The 7x7cm - 2.8"x2.8" Solid slats are made of 100% FSC® hardwood attached to Streetlock® combs with stainless steel anti-theft flange nuts.

Length            234cm - 92"  
 Seat height      47cm - 19"



Solid Tree Planters  
 Mobile Green Isles  
 Solo Bridges  
 See also:



**SOL-TD-L7-234-AL + SOL-L-CBR-120**  
 234x53x47cm  
 92"x21"x19"



**SOL-TD-L7-234-CT + SOL-L-CBR-120**  
 234x53x47cm  
 92"x21"x19"

The client fitted these Solitude benches in Åndalsnes, Norway with LED lighting. The subtle lighting on the CorTen steel supports lends an extra-friendly and inviting air to the benches.



## Solid Love Benches



The **Solid Love Benches** are simple, low benches, with a noble appearance. Particularly attractive for rooftops and private residential areas due to their lightness in weight and aesthetic. The FSC® hardwood slats (7x7cm - 2.8"x2.8") are mounted in our Streetlock® comb system, leaving a space between the slats of only 8mm - 0.3".

These Solid Love Benches can be perfectly combined with our stainless steel Love Tubs: please refer to category 'Tree products' of this brochure. A fine example is the Spui square in The Hague (NL), which was furnished with 14 large Love Tubs bearing the city's kite logo.

Lengths 234cm - 92" and 300cm - 118"  
 Widths 60cm - 24" and 90cm - 35"  
 Material stainless steel SS 316 or aluminium



**SOL-LB-L8-62-ST**  
 62x62x47 cm  
 24"x24"x19"



**SOL-LB-L12-234-ST**  
 234x93x47 cm  
 92"x37"x19"



**SOL-LB-L8-234-ST**  
 234x62x47 cm  
 92"x24"x19"



Design: Streetlife  
 Protected by int. Model Depots and Patents

See also:  
 Solid Tree Planters  
 Mobile Green Isles  
 Solo Bridges

Streetlife Brochure 2018 - 2019

## Solid Top Seats



**Solid Top Seats** are linkable modules made of FSC® hardwood that are mounted onto a stone or sheet metal base. Their FSC® hardwood slats (7x7cm - 2.8"x2.8") are sturdy and solid. They are fitted using the patented Streetlock® comb system with stainless steel theft-proof flange nuts. The seat can be invisibly installed onto the base structure.

Widths 46cm - 18" (6-slats)  
 62cm - 24" (8-slats)  
 93cm - 37" (12-slats)



Design: Streetlife  
 Protected by int. Model Depots and Patents

Solid Tree Planters  
 Mobile Green Isles  
 Solo Bridges

Streetlife Brochure 2018 - 2019



**SOL-L6-TOP-234 + SOL-L6-TOP-300**  
 234x46x9 cm / 300x46x9 cm  
 92"x18"x3½" / 118"x18"x3½"



**SOL-L8-TOP-234 + SOL-L8-TOP-300**  
 234x62x9 cm / 300x62x9 cm  
 92"x24"x3½" / 118"x24"x3½"



**SOL-L12-TOP-234 + SOL-L12-TOP-300**  
 234x93x9 cm / 300x93x9 cm  
 92"x37"x3½" / 118"x37"x3½"





Design: Streetlife  
Protected by int. Model Depots and Patents

Solid Tree Planters  
Mobile Green Isles  
Solo Bridges  
See also:

Streetlife Brochure 2018 - 2019

## Solid Staple Benches

**NEW**



**SOL-STA-200-60-PC**  
202x60x48 cm  
80"x24"x19"



**SOL-STA-200-60-PC-CG**  
202x60x48 cm  
80"x24"x19"



**SOL-STA-200-120-PC**  
202x120x48 cm  
80"x47"x19"



**SOL-STA-5200-PC**  
202x200x48 cm  
80"x79"x19"



**Solid Staple Benches** comprise sturdy, crosswise-positioned Solid slats (7x7cm - 2.8"x2.8") on an integrated steel structure. The bench spans two metres. The benches have a slender design, but have a powerful architectural impact. The colour variations in the high-quality FSC®-100% hardwood create a beautiful texture that appeals to everybody.

The steel base structure is standard finished in grey; however, other RAL colours are available on request. Despite its slender appearance, the bench is strong and rigid. The steel supports are anchored to the ground with concealed attachments. Solid Staple Benches are not only suitable for outdoor use, but are also ideal for large indoor spaces, such as airport waiting areas, station halls and platforms.

Length 200cm - 79"  
Width 60cm, 120 cm & 200cm





## Solid Staple Plus Benches

**Solid Staple Plus Benches** comprise sturdy, crosswise-positioned Solid slats (7x7cm - 2,8" x 2,8") on an integrated steel structure. The longest bench spans an impressive four metres. The benches have a slender design, but have a powerful architectural impact. The colour variations in the high-quality FSC®-100% hardwood create a beautiful texture that appeals to everybody. The steel base structure is standard finished in red; however, other RAL colours are available on request. Despite its slender appearance, the bench is strong and rigid. The steel supports are anchored to the ground with concealed attachments. Solid Staple Plus Benches are not only suitable for outdoor use, but are also ideal for large indoor spaces, such as airport waiting areas, station halls and platforms.

Length 300 or 400cm – 118" or 157"

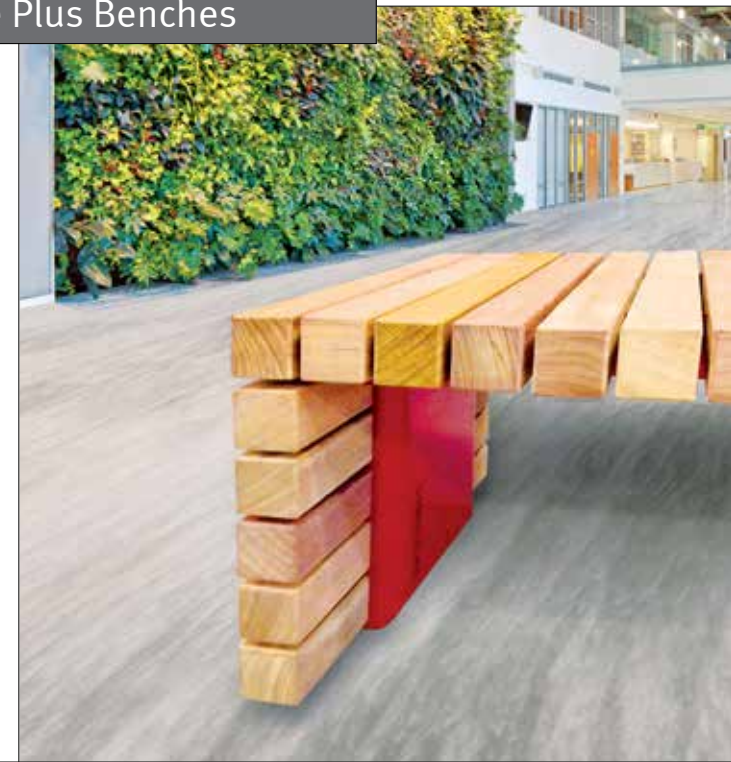

Solid Tree Planters  
Mobile Green Isles  
Solo Bridges

See also:

Streetlife Brochure 2018 - 2019

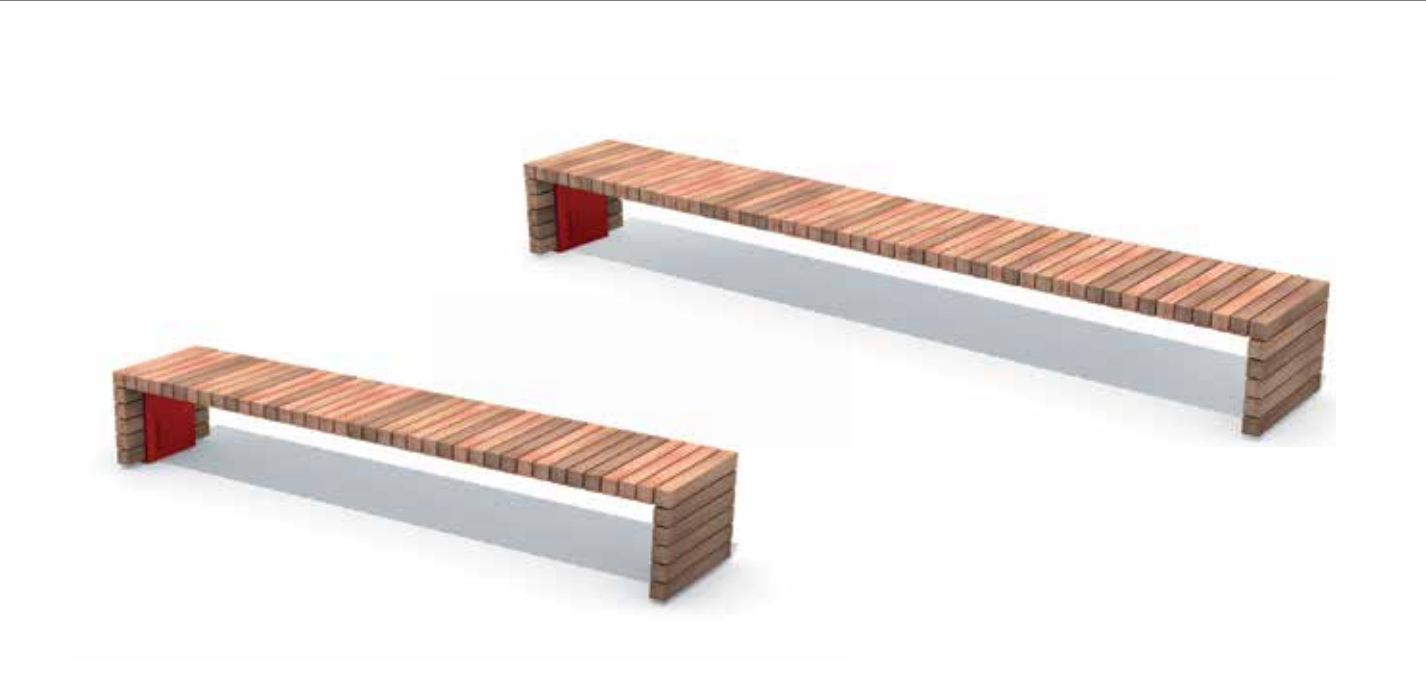

**SOL-STA-300-60-PC / SOL-STA-400-60-PC**  
296x60x48 cm / 397x60x48 cm  
117x24x19 / 156x24x19

Solid Staple Plus Benches are slender and have a powerful architectural impact. They are not only suitable for application outside, but are also real eye catchers for waiting areas at airports and railway stations.





Design: Streetlife  
Protected by int. Model Depots and Patents

Solid Tree Planters  
Mobile Green Isles  
Solo Bridges

See also:

Streetlife Brochure 2018 - 2019

## Solid Staple Plus Picnic Set

NEW

The long **Solid Staple Picnic Sets** have crosswise Solid slats of 7x7 cm on a powder coated steel base. At 300 cm the table length is oversized in comparison to the 200 cm benches which makes it easy to sit down. The design is distinctive and very detailed. These picnic sets are available in multi-coloured FSC® hardwood as well as in sustainable Cloudy Grey. This Cloudy Grey material consist of 50% recycled LPPE plastics combined with 50% recycled textile fibres and remnants.

Air inclusions on the top side of the Cloudy Grey slats are a unique feature of the manufacturing process and should not be considered a flaw. The grey marbled appearance has its own unique character and pricewise the picnic set in Cloudy Grey is an interesting option!

Table dimensions 250/300/350 x 80 cm - 98"/118"/138" x 31"  
Bench dimensions 200/300 x 50 cm - 80"/ 118" x 19"

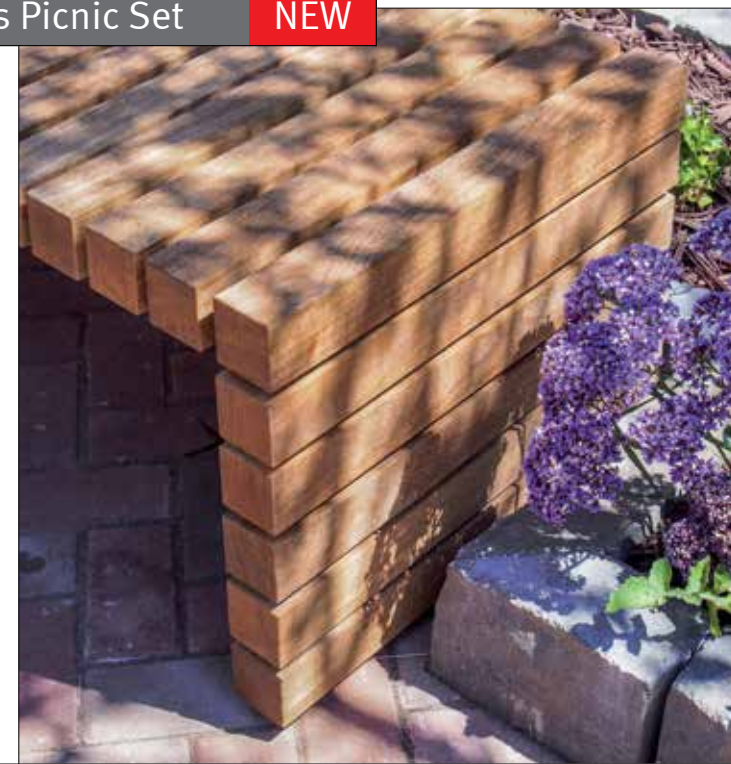

**SOL-STA-PT-300-80-PC + 2X SOL-STA-200-50-PC**  
300x80x79 cm + 202x50x48 cm  
118"x31"x31" + 80"x20"x19"



**SOL-STA-PT-300-80-PC-CG + 2X SOL-STA-200-50-PC-CG**  
300x80x79 cm + 202x50x48 cm  
118"x31"x31" + 80"x20"x19"





These benches were created in close collaboration with Andropogon Associates Ltd. The photographs were taken outside the new Korman Center at Drexel University in Philadelphia. Photo © Graham Hebel

## Solid Peano Benches

NEW

The **Solid Peano Benches** are angular benches with a solid, closed design fitted with FSC® hardwood slats measuring 7x7cm. The benches are linked with attractive joins to create an angular (90°) configuration or a straight extended arrangement. In the corner arrangement the beams are mounted in a tooth pattern.

Dimensions: 210x210x47 cm.

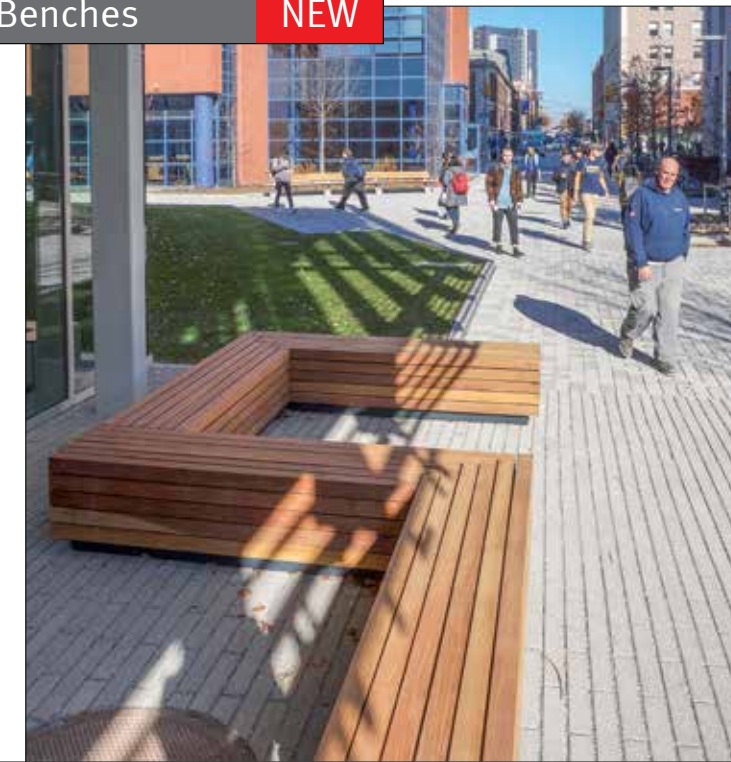
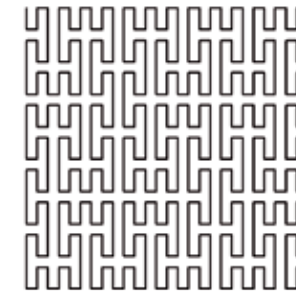

Solid Tree Planters  
Mobile Green Isles  
Solo Bridges  
See also:

Giuseppe Peano was an Italian mathematician, philosopher and logician. His publication on the space-filling curve was released in 1890. The “Peano Curve” is not actually curved; it’s a line with 90° angles as shown above.

Source: **Bruno Munari**; *Square, Circle, Triangle* (1960, 2005)



**4X SOL-PEA-L14-END-234-TH**  
936x46x47 cm  
368"×18"×19"

Streetlife Brochure 2018 - 2019





Design: Streetlife  
Protected by int. Model Depots and Patents

Solid Tree Planters  
Mobile Green Isles  
Solo Bridges

See also:

Streetlife Brochure 2018 - 2019

## X-Table Picnic Set

The **X-Table Picnic Set** is a sturdy picnic table with diagonal supports. The metal supports extend elegantly to support the 2 long benches. The resulting design is quite striking. Also available as a separate table for use on roof terraces etc.

The tabletop consists of 12 Solid slats (7x7cm - 2.8"x2.8") made of 100% FSC® hardwood. They are attached by flange nuts to the Streetlock® comb system, with a gap width of 8mm. This creates a thick, solid wooden tabletop. The supports are available in galvanized steel or RAL coated. When linked together using a central connection support, the tables measure 470cm in length and can seat up to 16 people.

Tabletop 93x234cm - 36" and 92"



**X-PS-234-TH**  
234x164x44/75 cm  
92"x65"x17"/30"

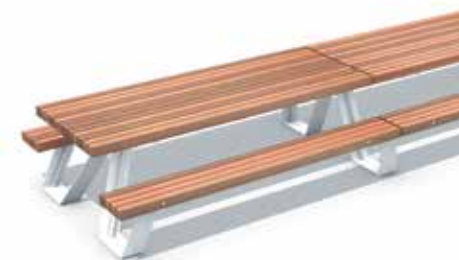

**X-PS-234-TH + X-PS-234-TH-EXT**  
468x164x44/75 cm  
184"x65"x17"/30"

The dynamic design of the distinctive X Tables makes them ideal for university campuses as well as playgrounds.  
Above: Calgary AB, Canada. Right: Harvard University in Cambridge, MA, USA.





Design: Streetlife  
Protected by int. Model Depots and Patents

Solid Tree Planters  
Mobile Green Isles  
Solo Bridges  
See also:

Streetlife Brochure 2018 - 2019

## Solid Industry Picnic Set

**NEW**

The **Solid Industry Picnic Set** has a cool, sturdy appearance thanks to its slanted industrial-look supports in anthracite grey. The beautifully designed sheet steel supports give a nod to the traditional casting used in industrial workbenches. The FSC® hardwood is a multi-coloured red-brown. The 4-slat seating module (30cm deep) and 10-slat tabletop module (77cm deep) are mounted on the stainless steel Streetlock® system, which extends the set's lifespan considerably thanks to the ease of replacing the slats.

Length 234cm & 300cm  
Width approx. 160cm

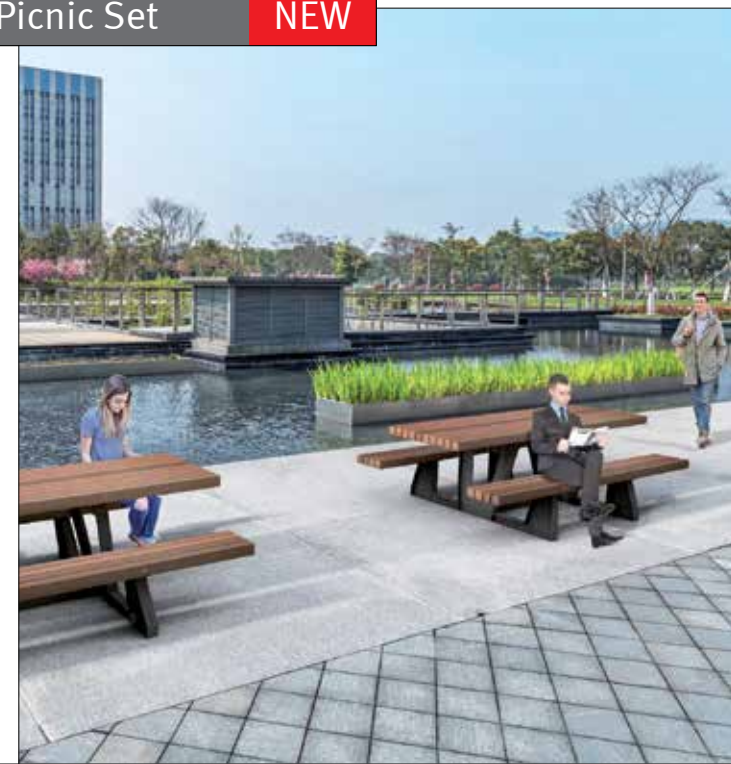

**SOL-IND-PS-300-PC**  
300/234x158x45/77 cm  
118"/92"x62"x18"/30"



**SOL-IND-PS-234-PC**  
234/180x158x45/77 cm  
92"/71"x62"x18"/30"



**SOL-IND-PS-300-PC**  
300/234x158x45/77 cm  
118"/92"x62"x18"/30"





Design: Peter Krouwel  
Protected by int. Model Depots and Patents

Solid Tree Planters  
Mobile Green Isles  
Solo Bridges  
See also:

Streetlife Brochure 2018 - 2019

## Solid Meet&Work System



**M&W-LBS-120**  
155/110x45x45 cm  
61"/43"x18"x18"

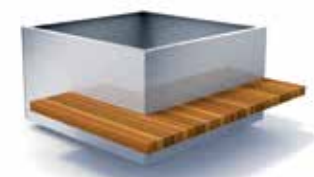

**M&W-TUB-120-AL + M&W-LBW-120**  
120x120x90 cm + 155/110x45x45 cm  
47"x47"x35" + 61"/43"x18"x18"



**M&W-TS-150-AL**  
148x150x75 cm  
58"x59"x30"



**M&W-TS-S120-110-AL + M&W-TS-FR-TH**  
116x120x110 cm  
46"x47"x43"



**M&W-TUB-150-AL + M&W-LBW-150 + M&W-TS-150-AL + M&W-LBS-150**

The **Solid Meet&Work System** consists of various landscaping elements with which playful configurations can be created in public places, on roof terraces and at meeting points. The combinations of benches, tables and tree planters offer innovative alternatives to traditional picnic settings and are ideal for creating attractive recreational areas for both short and longer stays. The various elements are made of aluminium with FSC®- 100% hardwood Solid slats (7x7cm - 2.8"x2.8").

Endless layout variations are possible with the various Solid Meet&Work landscaping elements. This high-quality system is for example ideal for the outdoor area of a large office complex. Flexible workstations and meeting areas can be combined with sustainable greenery.



The Solid Meet&Work System consists of various landscaping elements with which playful configurations can be created in public places, on roof terraces and at meeting points. Shown above are configurations at the Nordea Bank in Oslo, Norway.





## Solid Picnic Tables

The **Solid Picnic Tables** have a simple, restrained design. Both the wooden table leaf and the steel supports are unbroken (solid) in appearance. The table belongs to the Solid Series.

The FSC® hardwood slats (7x7 cm - 2.8"x2.8") are attached to Streetlock® combs, giving an 8 mm gap between the individual slats. The sturdy slats are attached with stainless steel rods, and anti-theft flange nuts. The closed plate steel supports can be galvanized or finished in RAL coating. The supports can be invisibly mounted.

As a result of their sturdiness and minimalistic design the Solid Picnic Tables are highly suitable for use in schools, on campus grounds etc.

Lengths 234 and 300cm - 92"x118"

Tabletop 92x234 and 92x300cm - 36"x92" / 36"x118"



Solid Tree Planters  
Mobile Green Isles  
Solo Bridges

See also:



**SOL-PS-6-300-PC + 2X SOL-PS-6-300-PC-EXT**  
900x193x"45/78cm  
354"x76"x18"/31"

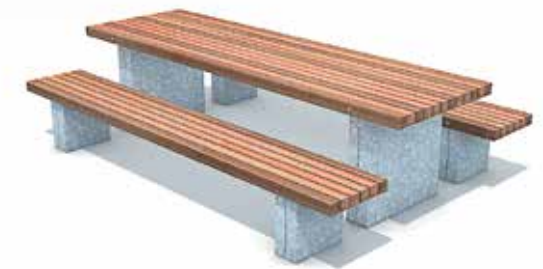

**SOL-PS-6-300**  
300x193x45/78cm  
118"x76"x18/31"

Streetlife Brochure 2018 - 2019





Design: Streetlife  
Protected by int. Model Depots and Patents

Solid Tree Planters  
Mobile Green Isles  
Solo Bridges

Streetlife Brochure 2018 - 2019

## Solid Serif Benches

**Solid Serif Benches** combine a seat made of Solid slats (7x7cm - 2.8"x2.8") with a Rough&Ready locking beam (7x15cm - 2.8"x5.9"). The spacious benches can be equipped with a beautifully designed double backrest that provides excellent ergonomic support for both shorter and taller people. The generously dimensioned benches can be extended as desired. The supports are made of thick-walled CorTen steel and can be optionally finished in a RAL coating.

Lengths 234cm and 300 cm - 92" and 118"  
Widths 9-slat, 70cm - 28" & 15-slat, 116cm - 46"



**SER-L9-300-PC**  
300x70x45cm | 118"x28"x18"



**SER-L15-234-PC + SOL-L-2CBBR-180**  
234x116x45cm | 92"x46"x18"



**2x SER-L6-TOP-234 + 2x SER-L6-TOP-corner**  
234x46x15cm | 92"x15"x6"





## Serif Type Font

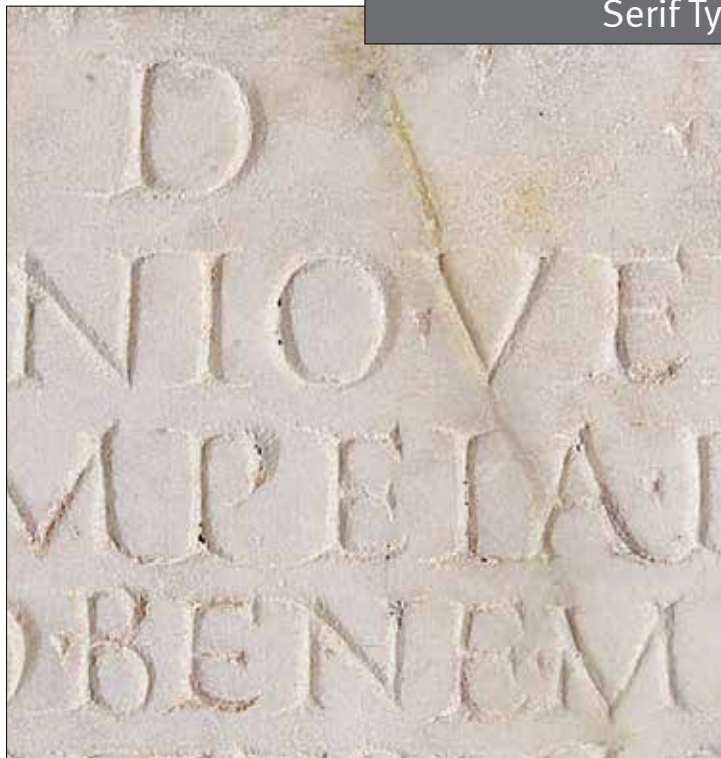

Serif refers to a term in typography that distinguishes between letters with a small line at the end of the main stroke of the letter (the serif) and those without a line (sans-serif). The use of serifs dates back to ancient Rome, when Latin letters were inscribed into stone. Beautiful examples of Serif letters can still be found on many ancient Roman marble inscriptions. The Serif helped stone cutters create a straighter and neater inscription.

The wide beam that finishes Streetlife's Solid Serif Benches is reminiscent of the attractive flourish that adorns Roman typography.



Serif

Design: Streetlife  
Protected by int. Model Depots and Patents

See also:  
Solid Serif Benches  
Solid Serif Hug a Tub  
Solid Bike Racks

Streetlife Brochure 2018 - 2019

## Solid Serif Chaise Longue

The **Solid Serif Chaise Longue** has an appealing wave shape. It is a recliner that is perfect for relaxing in the sun. The wave-shaped seat is made of 70 or 120cm-long Solid beams (7x7cm - 2.8"x2.8"). It is finished with two broad, sturdy beams – the Solid Serifs. The Chaise Longue has a floating effect above grass. The steel support is galvanized or CorTen and can be anchored.



**SER-LNG-70-TH**  
171x70x102 cm  
67"x28"x40"



**SER-LNG-120-CT**  
171x120x102 cm  
67"x47"x40"



Design: Streetlife  
Protected by int. Model Depots and Patents

See also:  
Solid Serif Benches  
Solid Serif Hug a Tub  
Solid Bike Racks

Streetlife Brochure 2018 - 2019





## Solid Skirt Circular Benches



**SKT-CI-R175**  
Ø3,5 - 1100x50x45cm  
0"x0"x0"



**SKT-CI-R225**  
Ø4,5 - 1400x60x45cm  
0"x0"x0"

**Solid Skirt Circular Benches** are beautifully detailed circular bench configurations made from repeating hardwood corner elements. The sturdy wooden posts (7x7cm - 2.8"x2.8") run gently inwards and float above the ground, affording the solid circular shape a delicate and graceful character. The colour variations in the high-quality FSC®-100% hardwood create a beautiful texture, which immediately speaks to the imagination. These unique circular benches are suitable for both outdoor and indoor spaces, including atriums.

A high-tech structure of curved steel components link and support the overall shape. This structure was RAL- coated in anthracite grey.

Diameter sizes 350cm, 450cm and 550cm  
138", 177" and 217"

Solid Skirt Circular Benches	R175	R225	R275
Outer diameter	350 cm	450 cm	550 cm
Inner diameter	250 cm	330 cm	430 cm
Seat length	± 11 m	± 14 m	± 17 m
Sitting depth	50 cm	60 cm	60 cm
Sitting height	45 cm	45 cm	45 cm
Number of supports	6	7	8



Design: Streetlife  
Protected by int. Model Deposits and Patents

See also:  
Solid Serif Benches  
Solid Serif Hug a Tubus  
Solid Bike Racks

Streetlife Brochure 2018 - 2019

## Solid Skirt Benches & Top Seats

**NEW**



Design: Streetlife  
Protected by int. Model Deposits and Patents

See also:  
Solid Serif Benches  
Solid Serif Hug a Tubus  
Solid Bike Racks

Streetlife Brochure 2018 - 2019

The **Solid Skirt Top Seats** are elegant curved seating modules of 120cm. The Skirt Benches feature a distinctive attractive and strong corner joint between the seat and the upright sections. The Solid Skirt Top Seats are designed to be mounted on curved concrete walls (D ≥ 7m). The transverse Solid slats (7x7cm) create a natural anti-skate solution.

The Top Seat Modules are prefabricated and are fitted on a hot-dip galvanized sheet steel base (height = 5cm). The seating depth is ca. 50 or 60cm. The Skirt front slats are 28cm. The high back is 35cm high.

**Solid Skirt Benches** are long and wide benches with an appealing design. The Solid supports on both sides create a closed, block structure of repeating segments. The supports are positioned at a slightly inward angle and transition harmoniously with the bench seat. The wooden segments are fitted into place using the Streetlock® comb system. Both the steel frame and two side plates can be galvanized or powder coated.



**SKT-275-90**  
275x90x47cm  
108"x35"x19"



**SKT-C-TOP-120-50 + SKT-C-BR-60 / SKT-CW-TOP-120-50**  
120x50x9 cm / 124x50x9 cm  
47"x20"x3½" / 49"x20"x3½"







KEW GARDENS • A PLACE OF INNOCENT AMUSEMENT

NEW YORK BOTANICAL GARDEN





Design: Streetlife  
Protected by int. Model Depots and Patents

Solid Serif Benches  
Solid Serif Hug a Tubs  
Solid Bike Racks

See also:

Streetlife Brochure 2018 - 2019

## Solid San Marco Seats



**Solid San Marco Seats** are single-block low benches which are especially suited for grassy areas. A separate ground console is first installed flush with the ground. This makes for a harmonious transition between the ground and console. The bench is then mounted onto the console, with a slight angle for levelling. The design was inspired by centuries-old stone benches in Venice. The CorTen base structure can optionally be powder-coated in CorTen effect, as shown below. Another option for the seating element is to install FSC® hardwood Solid slats.

Length 200cm – 79” & 300cm – 118”

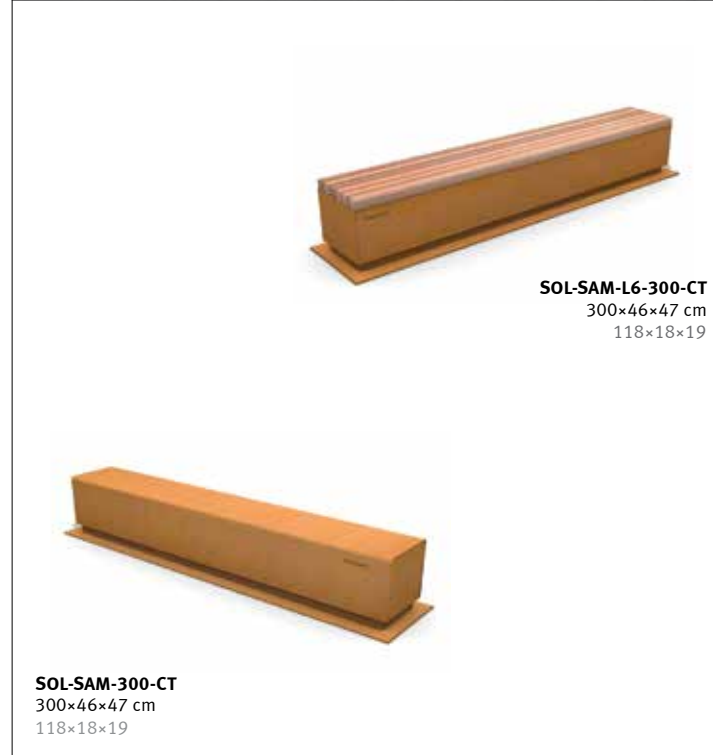
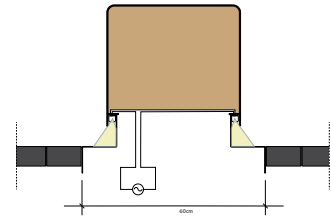





Design: Streetlife  
Protected by int. Model Depots and Patents

Solid Serif Benches  
Solid Serif Hug a Tubs  
Solid Bike Racks

See also:

Streetlife Brochure 2018 - 2019

## Solid Seat Strips

With the **Solid Seat Strips**, it is possible to install a long CorTen strip 47cm - 19" in height into the ground surface. Several functions, such as bench, waste bin, bicycle parking and greenery, can be incorporated in a single strip-shaped element. By reducing traditional, separate street furniture to a single, long line, one can create a streamlined and impressive urban landscape while reducing maintenance.

The above-ground cross-section is 47x47cm - 19"x19".  
We recommend an underground depth of approx. 20cm - 8".

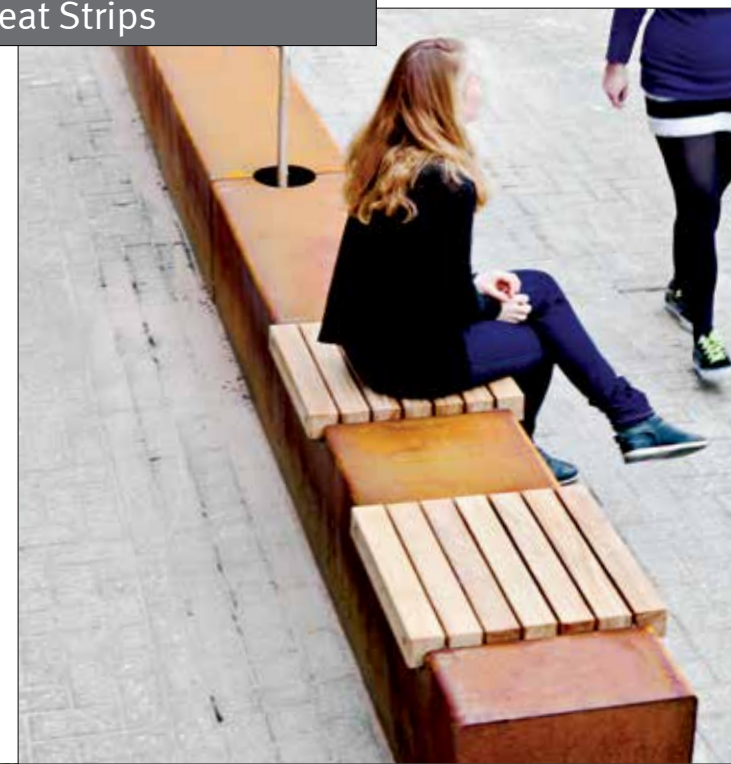

The bicycle parking model has a length of 300cm - 118" and incorporates 6 recesses to take the front wheels of 6 bikes. 3 CorTen bike rests are fitted separately to support bikes on both sides and enable them to be secured with a chain.





Design: Streetlife  
Protected by int. Model Depots and Patents

Solid Serif Benches  
Solid Serif Hug a Tubs  
Solid Bike Racks

See also:

Streetlife Brochure 2018 - 2019

## Solid Series Cloudy Grey

**NEW**



As an alternative to FSC® hardwood, Streetlife introduces the exceptionally hard-wearing **Cloudy Grey** beams measuring 7x7 cm. This material is 50% recycled LDPE plastic combined with 50% recycled textile fibres and remnants.

The textile waste mountain is an even bigger environmental issue than the plastic waste mountain but using Cloudy Grey beams means that these materials are recycled and given a new use! The grey marbled appearance has its own unique character.

Its technical properties make Cloudy Grey an attractive and fully-fledged alternative to wood. The beams are a maximum of 120cm in length. Solid products in which the beams are fitted crosswise are now also available in sustainable Cloudy Grey.



**SER-LNG-70-TH-CG**  
171x70x45/102 cm  
67x28x18/40



**SOL-BAS-S120-CG**  
120x120x45 cm  
47x47x18



**SOL-STA-200-60-PC-CG**  
202x60x48 cm  
80x24x19



**SOL-BP-70-TH-CG**  
70x7x75 cm  
28x3x30





Design: Streetlife  
Protected by int. Model Depots and Patents

Solid Serif Benches  
Solid Serif Hug a Tubs  
Solid Bike Racks

See also:

Streetlife Brochure 2018 - 2019

Solid Series Cloudy Grey

NEW

Streetlife's Solid Series is an extremely diverse range of products: from benches and bike parking to bridges and urban podia. The consistent application of a single beam size (7x7cm) and close spacing create a strong coherence throughout the series. The Solid identity is understated and minimal in terms of design. The sustainable Cloudy Grey beams (7x7cm) are a fully-fledged alternative to hardwood beams. The length of the Cloudy Grey beams is limited to 120cm.

This **Solid Curved Bench in Cloudy Grey** is constructed of 200cm modules that can be linked endlessly. The transverse positioning of the beams means that the Solid Curve Bench won't be damaged by skaters. The steel supports are made of hot-dip galvanized steel, CorTen steel, or powder coated.



**SOL-PL-D150-104-CG**  
150x104 cm  
59x41



**SOL-C-200-50-CG**  
200x50x45 cm  
79x20x18





## Cliffhanger Benches

The **Cliffhanger Benches** are hanging park benches attached to a sturdy wall. The finely detailed bench system has a modular interval of 120cm - 47". The prefab slat segments are composed of 5x5cm - 2"x2" 100% FSC® hardwood slats with an 8mm - 0.3" gap between each slat. The slats are mounted on the patented Streetlock® combs.

The slat segments are assembled with finger joints to reinforce the continuous character of these attractive hanging benches.

The Cliffhanger Benches are available as free standing benches. They are generously 100cm - 39" wide, low benches, which can also be equipped with medium or high slatted backrests. With and without it is possible to people sitting on two sides of the bench.



Design: Streetlife in association with Palmbout  
Protected by int. Model Depots and Patents

See also: Cliffhanger Shrubtub System

Streetlife Brochure 2018 - 2019



**CHP-L23-264**  
264x80x94 cm  
104x31x37



**CHP-L18-264**  
264x69x70 cm  
104x27x28



**CHP-L11-264**  
264x50x45 cm  
104x20x18



The Cliffhanger Park Benches are designed to decorate the edges of a site. The benches hover above the ground, so there is no accumulation of dirt. The staggered slats form finger joints between modules, and strengthen the crafted nature of the bench that tailors the edges of otherwise difficult level changes.





## Olympic Wave System

The **Olympic Wave Bench** was designed for the Olympic Parklands in cooperation with Hargreaves Associates, LDA Design London and Arup. A variety of long configurations have been installed by the Water Works in Stratford.

The generously dimensioned, slightly curving bench systems are constructed of hot-dip galvanized steel supports and 100% FSC® hardwood slat modules. The prefab slat modules, with 5x5cm - 2"x2" slats, are mounted on the patented Streetlock® comb system and have a length of approx. 90cm - 35". One end consists of a low, intermediate segment and an end segment that overhangs by 30cm - 12". The supports are anchored to underground bases.

Segment length	90cm - 35"
Height	120cm - 47"
Seat height	47cm - 19"



**2X OWB-D-L11-120 + 7x OWB-D-L19-90**  
 870x119x47/104 cm  
 342"x47"x18/41"

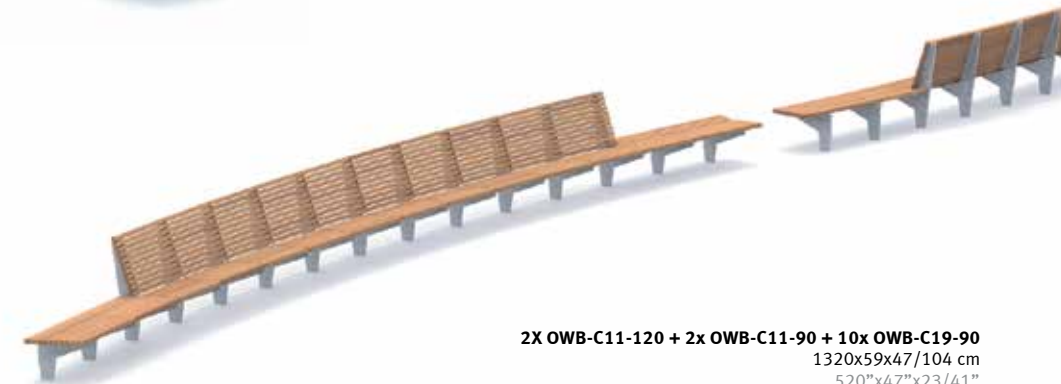

**2X OWB-C11-120 + 2x OWB-C11-90 + 10x OWB-C19-90**  
 1320x59x47/104 cm  
 520"x47"x23/41"

The Olympic Wave Bench was designed for the Olympic Parklands in cooperation with Hargreaves Associates, LDA Design London and Arup. A variety of long configurations have been installed by the Water Works in Stratford.



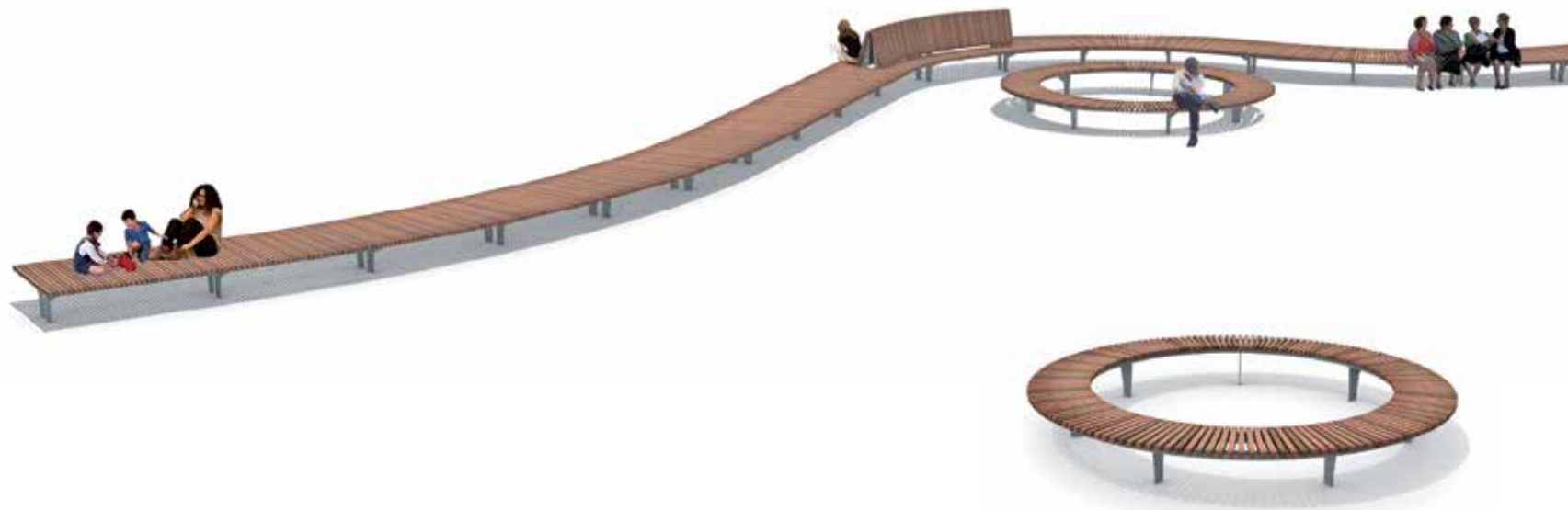

Design: Streetlife  
Protected by int. Model Depots and Patents

## Olympic Wave Crosswise System NEW

The original Olympic Wave Benches with long slats were designed for the 2012 London Olympic Games. At the request of the landscape architect company Hargreaves Associates, a new system has been developed featuring transverse (Crosswise) wooden slats measuring 5x5cm. The new **Olympic Wave Crosswise System** enables the realisation of more varied configurations, such as curved arrangements, two-sided seating (including double backs if desired) and circular benches. Our advisers will be happy to provide you with more information on the dimensions and possibilities.

Several arrangements will be installed in Oklahoma (USA) in the second half of 2018.

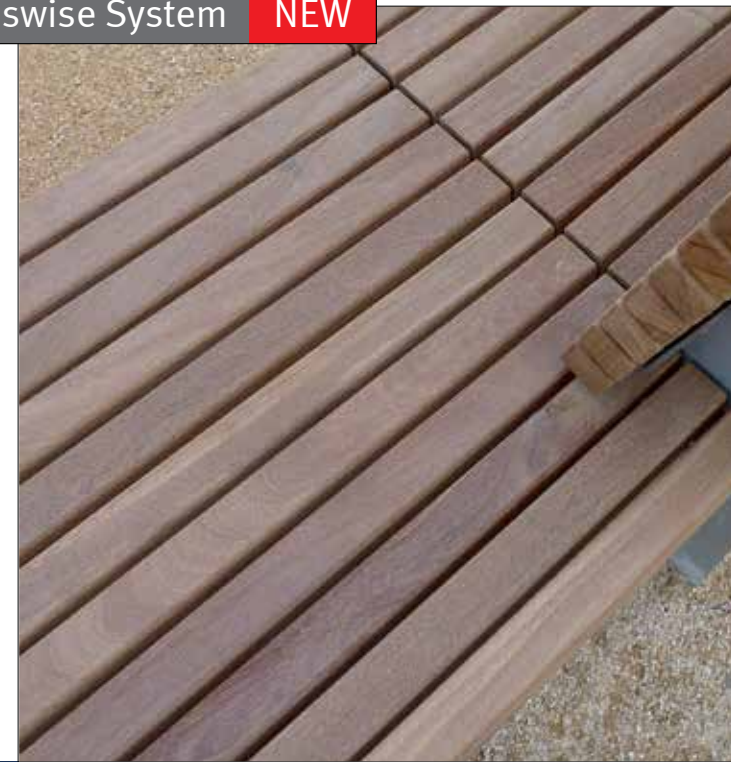

Streetlife Brochure 2018 - 2019





The central public zone on the Drexel University campus in Philadelphia has been refurbished by Andropogon Landscape Architects. The attractive Wood Top Modules form a transition between a green oasis and the pedestrian routes, creating leisure spots to rest and meet friends.

Design: Streetlife  
Protected by int. Model Depots and Patents

Streetlife Brochure 2018 - 2019

## Wood Top System

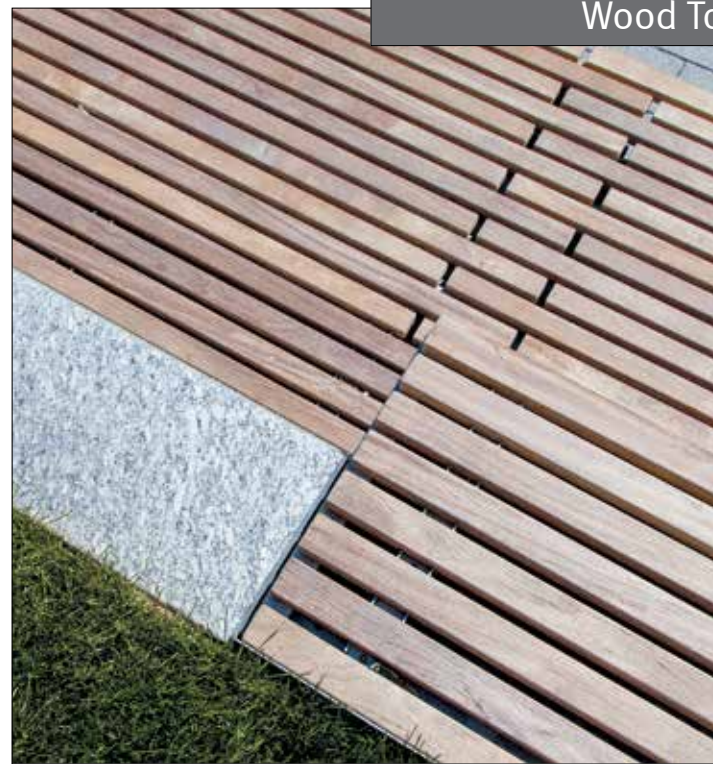

The **Wood Top System** consists of prefabricated slat modules that are invisibly mounted on a steel or concrete sub-construction. The prefab slat modules are mounted by means of stainless-steel Streetlock® comb fittings (in a mini-variant). Ultimately no screws are at all visible, yet the slats can easily be replaced in cases of maintenance. The slats are made of 100% FSC® hardwood: 35x57mm - 1.3"x2.2". The gap width between the slats is 15mm - 0.6". The front and back can be optionally finished with a vertical slat using the special, stainless steel, anti-theft flanged nuts. Horizontal as well as vertical assembly is possible.

Total height of element is 5.5cm - 2.2". Lengths: on specification of project drawing.

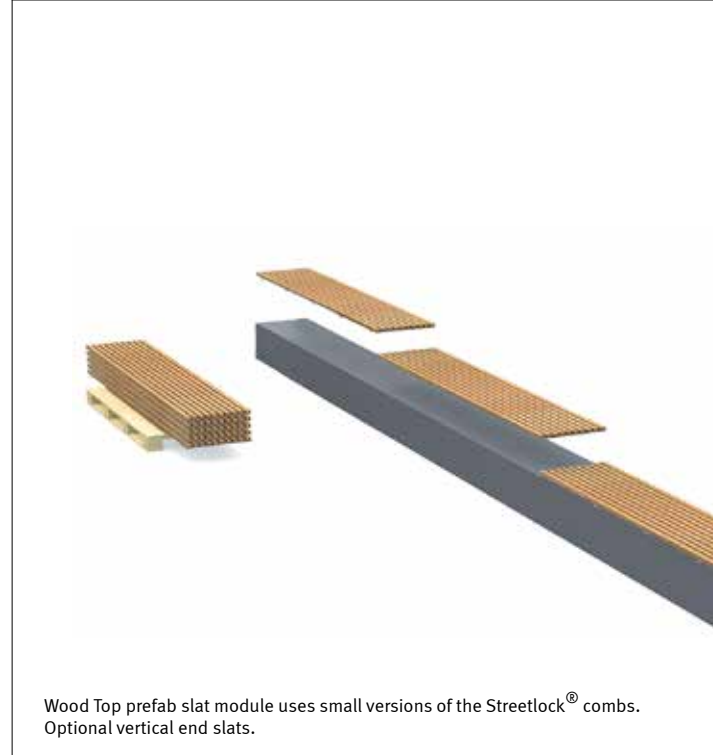

Wood Top prefab slat module uses small versions of the Streetlock® combs. Optional vertical end slats.





## Long&Lean Benches

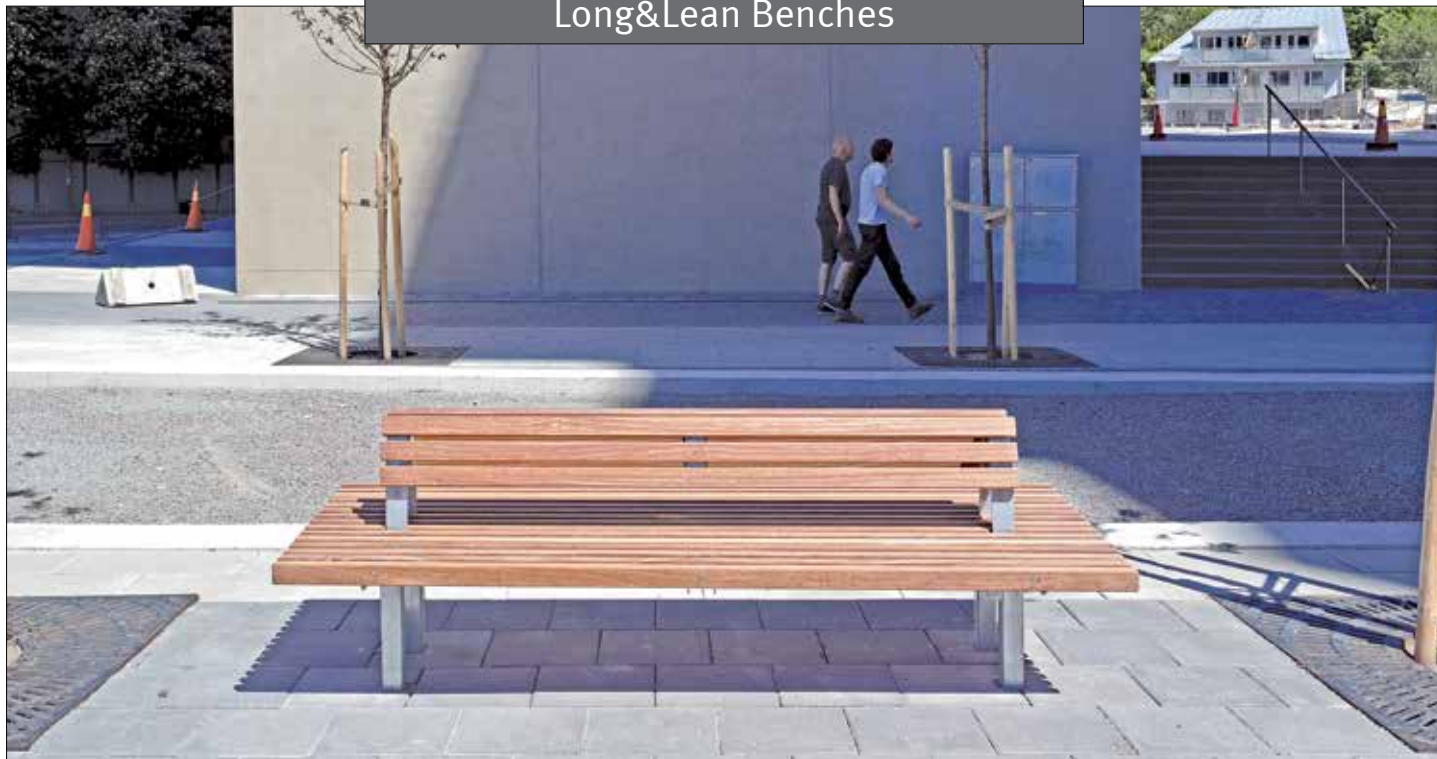

**L&L-L11-323**  
323x65x45  
127"x25"x18"



**L&L-L15-234**  
234x89x45  
92"x35"x18"



**L&L-L11-323 + L&L-BR-187**  
323x65x45  
127"x25"x18"



**L&L-L15-323 + L&L-BR-187**  
323x89x45  
127"x35"x18"

## Long&Lean Benches

The **Long&Lean Benches** provide flat seats made of extremely durable FSC® hardwood. The benches can be linked to form long, linear, architectural seating areas. Various lengths of backrests are available and are attached separately within the stainless steel Streetlock® comb system. As a result of the Streetlife Streetlock® the slats can be individually removed, replaced and are reversible so they can be used on both sides.

Lengths 234cm or 323cm - 92" or 127"  
Widths 65cm (one sided, 11 slats) - 26"  
89cm (two sided, 15 slats) - 35"

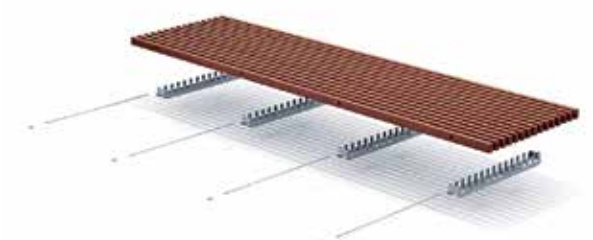

Patented Streetlock® stainless steel comb with theft-proof bolts.



Universal armrest stainless steel



**L&L-L-BR3-98**  
**L&L-L-BR3-187**



## Standard Picnic Sets

The **Standard Picnic Sets** have thick, sustainable FSC® hardwood slats (4x9cm - 2"x4"). The connecting table top allows space for wheelchairs and pushchairs. The thermo-galvanized or CorTen steel ground supports form the supporting frame for both the table and benches from a single underground unit. The floor supports are connected by a steel strip that has to be anchored.

In many outdoor locations it would be ideal to have one or two extra-long Picnic Tables instead of several smaller ones. Therefore, our picnic tables can be combined into one table of no less than 700cm - 275" Wheelchair users can occupy the mid-section of the table. The gap in the bench is also convenient for other users to slide in and sit down at the table.



**ST-PS-234-CT + ST-PS-234-Table-CT**  
702x153/73  
92"x60"/29"

**ST-PS-234-TH**  
234x153/73  
92"x60"/29"

Design: Streetlife  
Protected by int. Model Depots and Patents

Streetlife Brochure 2018 - 2019

## The New Standard Benches

**NEW**

The **New Standard Bench** replaces the Standard Bench from our previous collections. The use of two different slat heights creates a new, up-to-date look with greater bulk and comfort. Modules of 234cm long can be neatly and attractively connected to create super-long straight benches (468cm, 702cm, etc.) The FSC® hardwood is a multi-coloured red-brown. The slats are attached using the stainless steel Streetlock® comb system, which extends the lifespan of the benches considerably thanks to the ease of replacing the slats. The supports are made of hot-dip galvanized steel, powder coating is available on request.



**TNS-L6-234-TH + TNS-L6-234-TH-EXT**  
468x38/60x48/82 cm  
184x15/24x19/32

**TNS-L6-234-TH + 2X TNS-L6-234-TH-EXT**  
702x38/60x48/82 cm  
276x15/24x19/32

Design: Streetlife  
Protected by int. Model Depots and Patents

Streetlife Brochure 2018 - 2019







Design: Peter Krouwel  
Protected by int. Model Depots and Patents

## Horse Shoe Benches

Our **Horse Shoe Benches** have a minimalistic, yet distinctive design. The low benches are made of stainless steel (SS316) supports with rounded FSC® Cumaru slats: a very elegant and hard-wearing combination of materials that can withstand the ravages of time. The deep brown and red tones of the wood differs slightly in tint from slat to slat. Due to the typical round shape of a horse-shoe the seat is elevated and creates a surprisingly pleasant and active sitting position. This bench is easily integrated into architectural plans, both out- and indoors.

It is also available in a broader version for double-sided use. The bench is easy to anchor on to the ground because of its stainless-steel supports and is secured with stainless steel anti-theft mounting hardware.

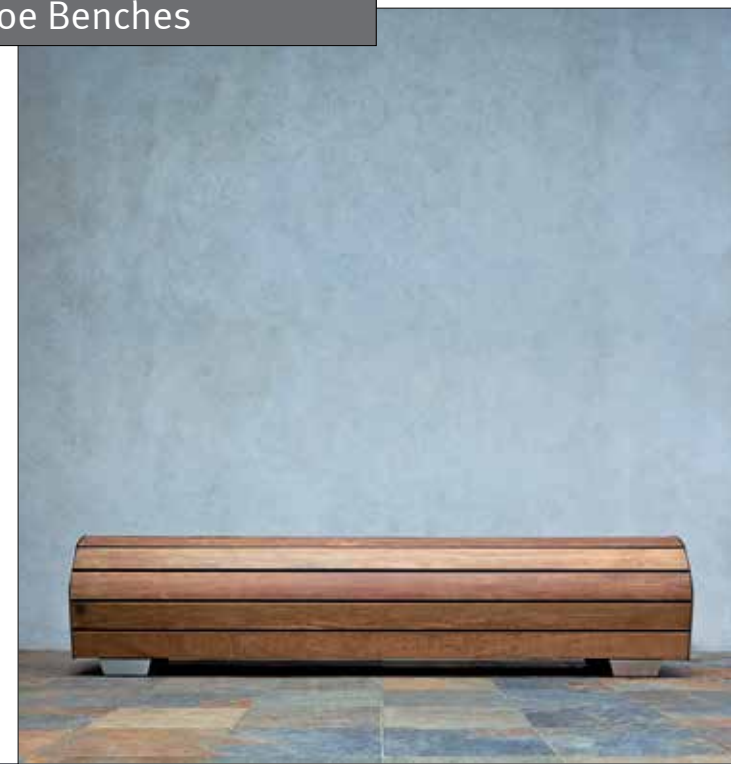

**HSB-L12-234**  
234×63×55 cm  
92×25×22



**HSB-L12-175**  
175×63×55 cm  
69×25×22



**HSB-L20-234**  
234×155×55 cm  
92×61×22



The Horse Shoe Benches are placed in a staggered configuration here, with the distinctive side view clearly visible. This photo was taken in Philadelphia, PA, in the United States.





Design: Streetlife  
Protected by int. Model Depots and Patents

Streetlife Brochure 2018 - 2019

## Highlife III Benches

**NEW**



**HLF-TOP-200-60**  
203×60×5  
80×24×2



**HLF-234-60-PC**  
234×60×47 cm  
92×24×19



**HLF-BR-234-PC**  
234×45/64×47/100 cm  
92×18/25×19/39



**HLF-BR-234-PC + HLF-BR-234-PC-EXT**  
468×45/64×47/100 cm  
184×18/25×19/39

The Highlife III style affords a contemporary and graphic character to new seating solutions. The alternating slat design is created using multi-coloured FSC® hardwood in three different widths. The slats are 38mm thick.

The elegant **Highlife III Benches** are extremely comfortable thanks to the high backs. The height is 45+55 = 100cm. The length is 170 or 234cm. The steel supports are hot-dip galvanized and finished with powder coating in anthracite grey.

The **Highlife III Top Seat modules** are 170 or 234cm long and 40, 50 or 60cm deep.







Design: Streetlife  
Protected by int. Model Depots and Patents

## Highlife III Picnic Sets

**NEW**

The Highlife III style features a contemporary, graphic character. The alternating slat design is created using 38mm-thick slats of multi-coloured FSC® hardwood in three different widths. The Highlife III Picnic Set is a stylish picnic table with an understated design.

The tabletop measures 234x90cm. The steel supports are hot-dip galvanized and finished with powder coating in anthracite grey.

The Highlife III product range is a complete family of street furniture including benches, Top Seats, picnic sets and tree planters.



**HLF-PS-234-PC + HLF-PS-234-PC-EXT**  
468x190x47/76 cm  
184x75x19/30

**HLF-PS-234-PC**  
234x190x47/76 cm  
92x75x19/30

Streetlife Brochure 2018 - 2019





Rough&Ready Big Green Benches



Rough&Ready Basic Hug a Tub **NEW**



Rough&Ready Low Tangram Tubs **NEW**



Rough&Ready Hug a Tub



Solid Green Benches



Solid Seat Blocks



Solid Air Tubs



Mobile Surf Isles **NEW**



Solid Surf Isles



Solid Terrace Curve



Solid Podium Discs **NEW**



Solid Edge System



Mobile Green Isles



Mobile Green Isles



Free Form Tree Isles

Category 3  
Green Benches, Tree Isles & Podiums

- Tree Isles
- Surf Isles
- Podium Isles
- Raised Borders



Solid Edge Green Benches **NEW**



Green Circular Benches



Cliffhanger Tubs



Solid Podium Isles



Rough&Ready Round Tree Isles



Rough&Ready Oval Tree Isles



Bento Tree Boxes



Rough&Ready Seat Walls





## Green Benches & Tree Isles

Combining greenery with recreational areas provides public spaces with an inviting allure. Not only is relaxing under a tree or flowering plant a very pleasant experience, the integration of street furniture also creates a diverse and multifunctional streetscape. In addition, it is much easier to keep the ground surface clean. The Streetlife Collection offers a number of standard solutions. Moveable products, such as Green Benches and Mobile Green Isles, are designed for placing on top of ground level and create mobile greenery. Tree Isles and Podium Isles with border seats are larger and are set into the pavement. This allows existing or new trees to take root in the open ground.

### 1. CorTen Walls

The CorTen walls have a natural warm appearance. The sustainable rust-forming surfaces discourages graffiti and stickers. The Isles can be attractively incorporated into the street paving by means of a permeable rubber joint several centimetres wide. CorTen steel edging is supported on **base plates** generally positioned 15cm below ground level. The walls are lightweight and the shallow foundation prevents damage to existing roots. The depth or height of the walls may be adjusted depending on the elevation of the ground-level package on a concrete deck.



### 2. Treetec® Bottom Up & Root ball anchorage

If required, a Streetlife Tree Isle can be equipped with a water reservoir and a Treetec® Bottom Up system, where capillary columns distribute water to the roots. With large trees, it may be necessary to have root ball anchorage. The Tree Isles can be equipped with this type of integral construction if necessary.

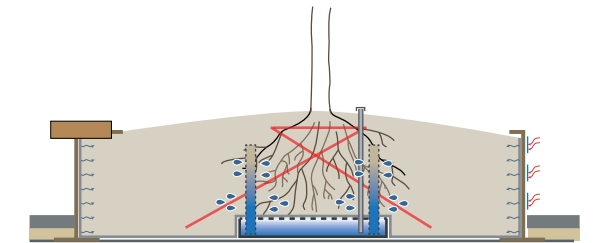

### 3. Ground creepers

The Isles are often equipped with a tree substratum that is applied in a slightly concave manner. Streetlife advises the use of ground creepers (such as ivy for example) in mat form on the substratum. This intensifies the green experience, and reduces maintenance as well as the accumulation of waste.







**Water Isle of Le Corbusier**

The Notre Dame du Haut chapel in Ronchamp (France) – designed by the famous Franco-Swiss architect Le Corbusier – is both a source of inspiration and an artistic reference within Streetlife’s identity. The chapel was built between 1950 and 1955, and forms a magnificent, sculptural concrete structure that attracts both architecture and landscape lovers alike. A concave, sloping concrete roof covers the entire chapel that drains at a central point via a protruding spout. Rainwater arcs down into a modernist design isle constructed in unfinished concrete. The isle acts as an overflow basin from which water flows to surrounding areas.

**4. Tree Air® Spots**

Streetlife now supplies a unique recessed spotlight incorporating the Tree Air® root aeration system (patent pending) that can be combined simply and effectively with CorTen steel tree grids and large tree planters. Heat generated by the spotlight establishes an additional airflow into the aeration channels if the channel is left open along one side. This system does away with the need for separate air grilles resulting in a neat and tidy finish.



**5. Rough&Ready sitting edge**

The R&R sitting edge is integrated into the steel. In the case of curved sitting edges, the minimum outer radius is 3 metres and the sitting width 40, 50 or 60cm - 16”,20” or 24”. The hardwood beams protrude around 5cm above the steel. They are invisibly mounted and are easy to replace. To realize an even seat height of 45 to 47cm - 18” to 19”, the ground-level drainage slope should be limited. The border seats can be made LED-Ready and can be optionally fitted with LED lighting by a third party.



**6. Wastepaper Bin**

Due to the large power of attraction of the Streetlife Tree Isles, it is advisable to incorporate Streetlife wastepaper bins in the Isles. These CorTen steel bins, with a 316 stainless-steel flap are partly sunken into the Isle. Accordingly, the ground level remains free of detached street furniture. The bin protrudes 45cm - 18” above the Isle, so that the deposit height is 90cm - 35”. The stainless-steel flap is opened by means of a triangular key.



**7. CorTen trunk protectors**

It is not recommended that moist substrate be placed around the trunk of existing trees. Streetlife has CorTen trunk protectors to avoid trunk rot, which can be covered by a grid if required. Old trees can also be integrated with a Tree Isle or Podium Isle.







Design: Streetlife  
Protected by int. Model Depots and Patents

Rough&Ready Benches  
Rough&Ready Tree Planters  
Rough&Ready Tree Isles  
Rough&Ready Bicycle Parking

See also:

Streetlife Brochure 2018 - 2019

## Rough&Ready Big Green Benches



**R&R-BGB-S-250-90**  
250x90x45cm  
98"x35"x18"



**R&R-BGB-S-250-90-AB**  
250x90x45cm | 98"x35"x18"



**R&R-BGB-S-300-90-PC**  
300x90x45cm  
118"x35"x18"



**2x R&R-BGB-S-300-90 + 2x R&R-T-BR1-234**  
600x90x45cm | 236"x35"x18"



**2x R&R-BGB-S-300-90-PC+ 2x R&R-T-BR1-234**  
600x90x45cm  
236"x35"x18"

The **Big Green Benches** are made of CorTen or double powder coated steel with a FSC® hardwood sitting edge. This sitting edge has developed over the years as one of our classic details: the wooden beams are for the most part embedded in the steel structure by means of the integrated Streetlock fix-and-replace® system.

These benches can be furnished with shrubs, bamboo or climbers. The benches are extremely solid but remain movable. It is possible to supply these benches with an Open Bottom (OB version) so that shrubs or larger trees can take root in the open ground. Their linear form make them extremely suitable for bamboo or climbers for façade greenery.

Dimensions 250x90x45cm, seating depth D= 40cm  
98"x35"x18" 16"

Dimensions 300x90x45cm, seating depth D= 50cm  
118"x14"x18" 20"



The Rough&Ready Big Green Benches in Houston, TX, are powder coated. The elongated, linked benches form a green barrier separating the busy street and the pedestrian area.





In recent years these gasholders in London have been redeveloped to become a sought-after real estate location. The outdoor space between the residential blocks features green islands of linked Big Green Benches and stone borders with R&R Top Seats.

Design: Streetlife  
Protected by int. Model Depots and Patents

Rough&Ready Benches  
Rough&Ready Tree Planters  
Rough&Ready Tree Isles  
Rough&Ready Bicycle Parking  
See also:

Streetlife Brochure 2018 - 2019

## Rough&Ready Big Green Benches



**R&R-BGB-S-180**  
180x180x45cm | 71"x71"x18"

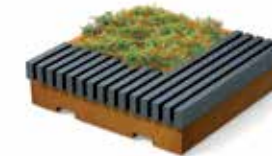

**R&R-BGB-L-150-AB**  
150x150x45cm  
59"x59"x18"



**R&R-BGB-D-180**  
180x180x45cm  
71"x71"x18"



**R&R-BGB-O-180**  
180x180x45cm  
71"x71"x18"

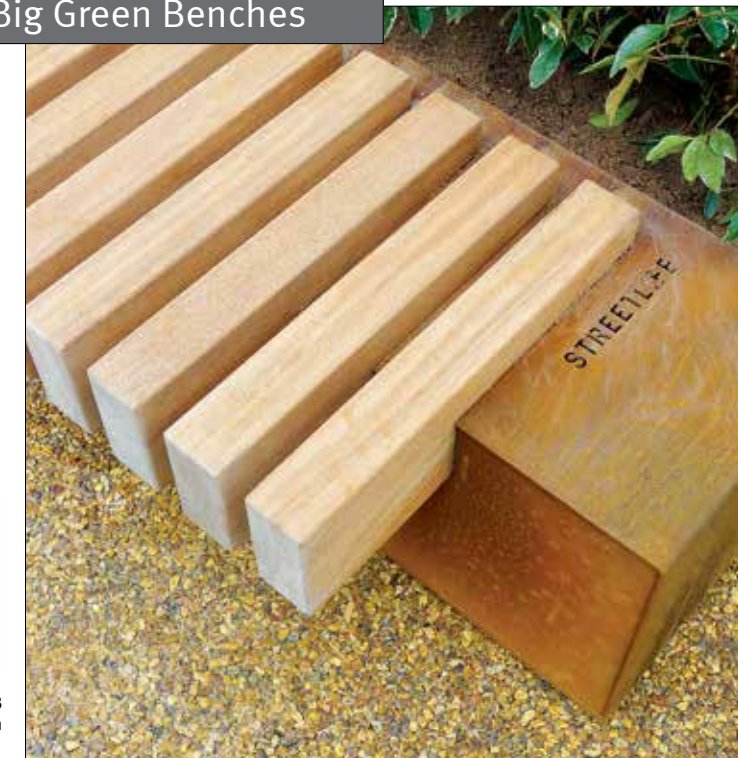

The **R&R Big Green Benches** are not only available in elongated versions, but also in square shapes: 150x150cm and 180x180cm - 59"x59" and 71"x71". The hardwood seats have been beautifully integrated into the steel structure by means of the patented Streetlock fix-and-replace® system. The border seats can be mounted one-sided, double-sided and corner-sided, as well as all around. All Black beams can be applied as an alternative to hardwood.

The steel structure is available with a Closed Base (CB) so that the bench remains moveable, or optionally with an Open Bottom (OB) so that a tree can take root in the open ground. The steel can be optionally double powder coated in a RAL colour.





Rough&Ready Tangram Tubs

NEW

Countless graphic Tangram patterns can be created by combining the three basic shapes (H = 47cm) of these low plant tubs. The CorTen tubs can be easily fitted with border seats using two R&R beams. The **R&R Tangram** plant tubs are crafted from CorTen, with or without a base construction.



**R&R-PL-TAN-TRI-130-150-CT**  
 130x150x47cm  
 51"x59"x19"



**R&R-PL-TAN-PAR-130-150-CT**  
 130x150x47cm  
 51"x59"x19"



**R&R-PL-TAN-TRA-130-300-CT**  
 130x300x47cm  
 51"x118"x19"







Design: Streetlife  
Protected by int. Model Depots and Patents

Rough&Ready Benches  
Shrubtub Tree Planters  
Rough&Ready Tree Isles  
Rough&Ready Bicycle Parking

See also:  
Streetlife Brochure 2018 - 2019

## Rough&Ready Hug a Tub

The Shrubtubs Tree Planters offer a stable base structure for mounting Rough&Ready wall benches and form the basis for the green **Rough&Ready** benches: **Hug a Tubs**.

The Hug a Tub configurations remain mobile, making temporary layout variations possible. They are a highly attractive option for councils looking to equip empty squares or concrete decks with green recreational areas. The robust R&R beams all run in the same direction, which allows for beautiful corner assemblies. The R&R wall benches can be mounted one-sided, double-sided and corner-sided, as well as all around.

Planter dimensions:  
150x150, 200x200 and 230x230 cm  
59"x59", 79"x79" and 91"x91"

Streetlife recommends using the Treteco® Bottom Up system in these stunning tree planters.



**R&R-HTUB-S-150**  
150x150x90cm  
59"x59"x35"



**R&R-HTUB-D-150-PC**  
150x150x90cm | 59"x59"x35"



**R&R-HTUB-L-200**  
200x200x90cm  
79"x79"x35"



**4x R&R-HTUB-L-230**  
460x460x90cm | 91"x91"x35"



The Hug a Tub units are made mobile with forklift provisions, which makes layout variations easy to accomplish and adapt. The green recreational areas can be moved without difficulty to make room for the weekly market or musical events.





Design: Streetlife  
Protected by int. Model Depots and Patents

Rough&Ready Benches  
Shrubtub Tree Planters  
Rough&Ready Tree Isles  
Rough&Ready Bicycle Parking

See also:

Streetlife Brochure 2018 - 2019

## Serif Hug a Tub



The Shrubtubs Tree Planters offer a stable base structure for mounting Solid Serif wall benches and form the basis for the green benches: **Serif Hug a Tub**. The serif wall bench is made of Solid slats (7x7cm - 2.8"x2.8") with a Serif locking beam (7x15cm - 2.8"x5.9").

The Solid Serif wall benches on these Hug a Tub tree planters are joined together at the corners. The corners are fitted in a unique wicker pattern, allowing for long beams to be added on all sides. The Hug a Tub configurations remain mobile, making temporary layout variations possible. They are a highly attractive option for councils looking to equip empty squares or concrete decks with green recreational areas. The Solid Serif wall benches can be mounted one-sided, double-sided and corner-sided, as well as all around.

Planter dimensions:  
150x150, 200x200 and 230x230 cm  
59"x59", 79"x79" and 91"x91"



**SER-HTUB-S-150**  
150x150x90cm, ± 2 m³ | 59"x80"x35"



**SER-HTUB-D-150-PC**  
150x150x90cm, ± 2 m³ | 59"x80"x35"



**SER-HTUB-L-150**  
150x150x90cm, ± 2 m³ | 59"x80"x35"



The wall benches on these Hug a Tub planters in Amerongen, the Netherlands, are joined together to create a unified whole. They are fitted in a wicker pattern at the corners allowing for long beams to extend out from the corner, creating an elegant look.





## Rough&Ready Basic Hug a Tub

**NEW**

**Rough&Ready Basic Hug a Tub**s are based on the robust-looking Basic R&R Tree Planters. They are made of heavy gauge galvanized steel covered with R&R FSC® hardwood beams. An integrated clean-lined look is achieved by fitting the beams in a way that they appear to go through the entirety of the structure.

These R&R Basic Planters can be optionally fitted with the Tretec® Bottom Up system.



**R&R-HTUB-BASIC-S-120-200-60-TH**  
120x200/250x45/90cm  
47"x79"/98"x18/24"

Design: City of Toronto and Streetlife  
Protected by int. Model Depots and Patents

Rough&Ready Benches  
Rough&Ready Tree Planters  
Rough&Ready Tree Isles  
Rough&Ready Bicycle Parking

See also:

Streetlife Brochure 2018 - 2019





Design: Streetlife  
Protected by int. Model Depots and Patents

Solid Benches  
Solid Tree Planters  
Mobile Green Isles  
Solo Bridges

Streetlife Brochure 2018 - 2019

## Solid Green Benches

The **Solid Green Benches** are made of CorTen steel with individual seats made of FSC® hardwood. These Solid seats measuring 50x50x7cm - 20"x20"x3" are fitted with a Streetlock® comb and partly embedded in the steel. These green benches are 450cm - 177" long.

The 225x180cm - 89"x71" rectangular model can also be doubled to 450 cm - 177". The Solid Green Benches are also available with an Open Base (OB model) so that shrubs or trees can take root in the soil below.

Measurement 450x90cm - 177"x35" & 225x180cm - 89"x71"  
Color CorTen steel or double powder coated (RAL)

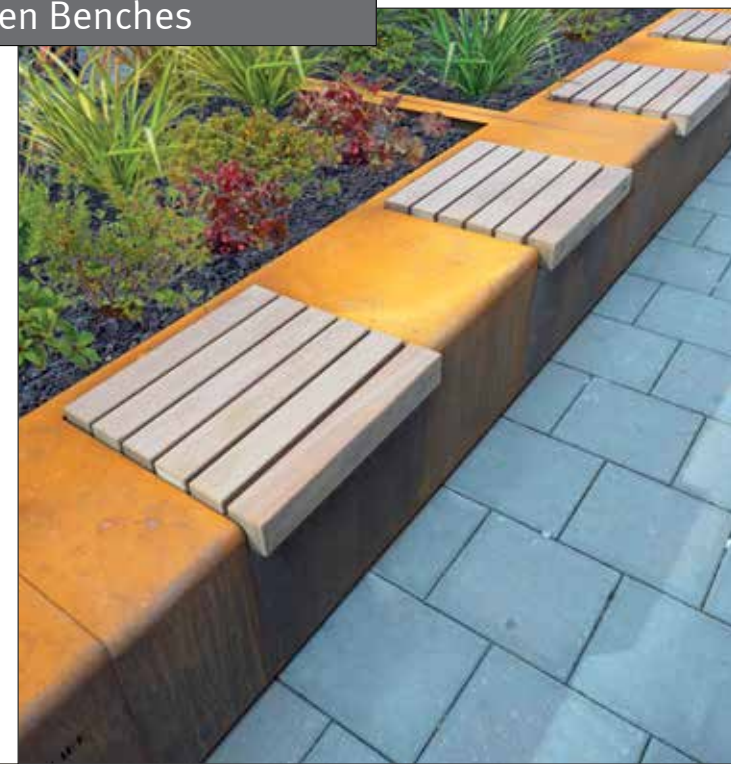

**SOL-GB-450-90-2ST50**  
450x90x40cm | 117"x35"x18"



**SOL-GB-450-90-4ST50**  
450x90x40cm  
117"x35"x18"



**SOL-GB-180-225-2ST50**  
180x225x40cm | 71"x89"x18"





Design: Streetlife  
Protected by int. Model Depots and Patents

Solid Benches  
Solid Tree Planters  
Mobile Green Isles  
Solo Bridges  
See also:

Streetlife Brochure 2018 - 2019

## Solid Seat Blocks



**SOL-SBL-600-TREE100 + 2X SOL-SBL-SEAT120 + 2X SOL-L-SBR-120**  
600x100x47cm  
236"x39"x19"



**SOL-SBL-450-TREE250-PC**  
450x100x42cm  
177"x39"x17"



**SOL-SBL-450 + 2X SOL-SBL-SEAT120**  
450x100x47cm  
177"x39"x19"

**Solid Seat Blocks** are sturdy design elements that allow benches, planters and tree boxes to be combined in a variety of appealing ways. Contrary to the narrow Solid Seat Strips, Solid Seat Blocks are wide elements of 100cm - 47" offering double-sided seating. The RAL-coated or CorTen modules can be seamlessly connected, creating an orderly and harmonious low-maintenance urban landscape design. The Solid Seat Blocks have a recessed plinth. The short Solid Softback backrest model is available as an optional add-on.

We recommend installing the Solid Seat Blocks 20cm - 8" below ground and using a semipermeable gutter with resin bound gravel when necessary.



**SOL-SBL-SEAT-120**  
120x109x47 cm



**SOL-L-SBR-120**  
120x15x34 cm



MODULE I  
**SOL-SBL-150**



MODULE II  
**SOL-SBL-150-TREE50**



MODULE III  
**SOL-SBL-150-TREE150**





The Solid Air Tub can be used to create low-maintenance roof gardens/terraces that make pleasant leisure environments. Pictured here: the roof terrace of the Wayland House apartment building in London, designed by PRP Architects. Photo © Richard Chivers.

## Solid Air Tub

**Solid Air Tub** can be used to create low-maintenance, recreational roof gardens and terraces. They are lightweight and their unique, patented wall construction allows more oxygen into the planter to circulate around the roots. By using Solid Air Tub, one can considerably reduce planter loads to 500 to 600kg/m<sup>2</sup>: The aluminium tub is only 1/3 of the weight of a steel tub. Further using a lightweight moist-retaining substrate can help to keep the overall load acceptable for rooftops.

Tree planters are available in various sizes and three heights (55cm, 70cm & 85cm - 22", 28" & 33"). By positioning Solid Air Tub at deck patio level, it is possible to integrate seating and shrubbery simply and effectively. Available in micropreen aluminium or RAL coating. Their base structure is made from a black composite material.

Planter dimensions: 120x120, 150x150 and 180x180 cm  
47"x47"x, 59"x59"x and 71"x71"



Design: Streetlife  
Protected by int. Model Depots and Patents

Solid Benches  
Solid Tree Planters  
Mobile Green Isles  
Solo Bridges  
See also:

Streetlife Brochure 2018 - 2019



Optional Treetec® Bottom Up: Tree roots need just as much oxygen as they do water. The walls of the Air Tub are constructed in such a way that much more oxygen can circulate that is the case with normal wall constructions.

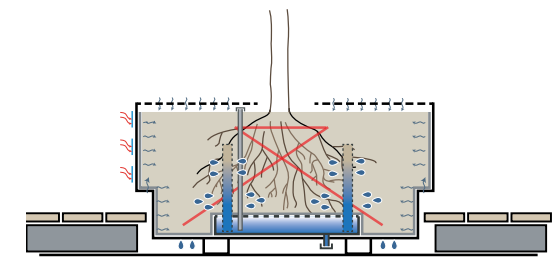

**ATUB-S150-70-AL + ATUB-L6-150**  
150x150x70cm, ±1.5m<sup>3</sup>  
59"x59"x28"



**ATUB-AL-S180-55**  
180x180x55cm, ±1.8m<sup>3</sup>  
71"x71"x22"





Design: Streetlife  
Protected by int. Model Depots and Patents

Solid Benches  
Solid Tree Planters  
Mobile Green Isles  
Solo Bridges

See also:

Streetlife Brochure 2018 - 2019

## Solid Edge Green Benches

**NEW**

These generously sized, movable **Solid Edge Green Benches** are available in four different formats and two main sizes: 180x180cm and 230x230cm - 71"x71" and 91"x91". Forklift slots can be included in the heavy gauge CorTen sheet construction if desired. An open base, which allows shrubs or trees to take root in the ground, is also an option.

The prefab slat modules with Solid slats of FSC® hardwood (7x7cm - 2.8"x2.8") are fitted with the stainless steel Streetlock® comb system. The Solid Edge Green Benches are well detailed, functional and deliverable with a special double powdercoating.

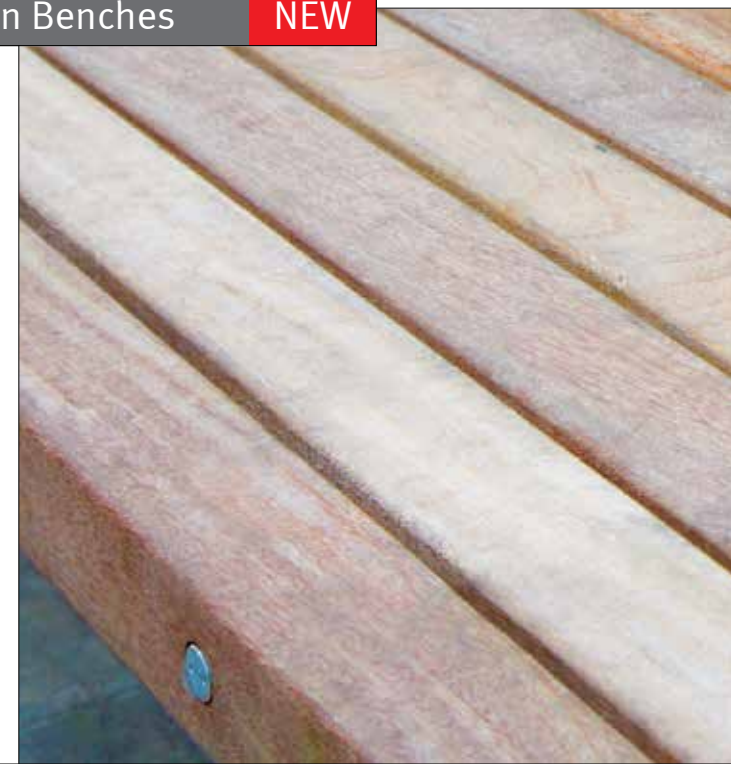

**SOL-EDG-GB-P-230-CT**  
91"x91"x19" | 230x230x47cm

**SOL-EDG-GB-D-230-CT**  
91"x91"x19" | 230x230x47cm

**SOL-EDG-GB-L-230-CT**  
230x230x47cm | 91"x91"x19"

**SOL-EDG-GB-S-230-CT**  
230x230x47cm | 91"x91"x19"





Design: Streetlife  
Protected by int. Model Depots and Patents

## Green Circular Benches

**Green Circular Benches** are mobile seating elements with a spacious tree planter in the centre. The circular bench has a seat comprising FSC®-100% hardwood slats with a standard dimension of 35x57mm - 1.4"x2.2" which are integrated in the construction. The seating elements are delivered completely pre-assembled. The structure consists either of aluminum (optionally RAL-coated) or a composite.

Green Circular Benches are planter elements that offer plenty of seating. Streetlife recommends equipping the tree planter with the Treetec® Bottom Up System.

Diameter    Ø 180cm and Ø 230cm - Ø71" and Ø91"  
Height        85cm - 33"

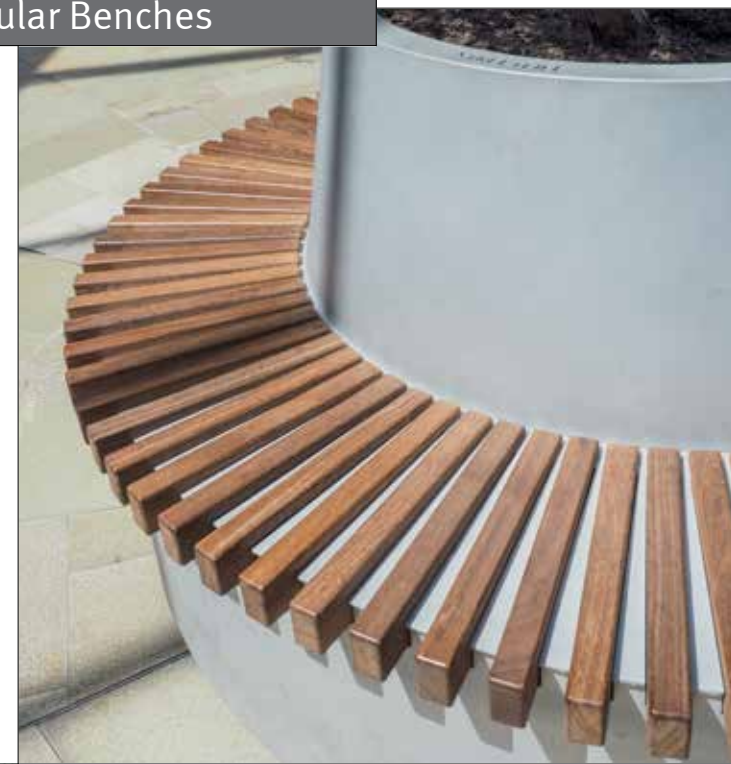

Green Circular Benches are planter elements that offer plenty of seating. These simple elements work perfectly in spaces such as stations, where they can accommodate waiting passengers. Photo: Den Bosch

Streetlife Brochure 2018 - 2019





Design: Streetlife in association with Palmbout  
Protected by int. Model Depots and Patents

Cliffhanger Benches  
Shrubtub Tree Planters

See also:

Streetlife Brochure 2018 - 2019

## Cliffhanger Shrubtub System

By combining the **Cliffhanger Park Benches** with Shrubtubs you can create flexible green areas. Upon flat pavements or concrete decks they are a simple way to introduce green and inviting seating areas. Corner benches can also be achieved and create more intimate arrangements. The thin slats have staggered ends to create finger joints between each module. The effect of these staggered slats provide a crafted finish and allow for long continuous seating along this beautiful bench.

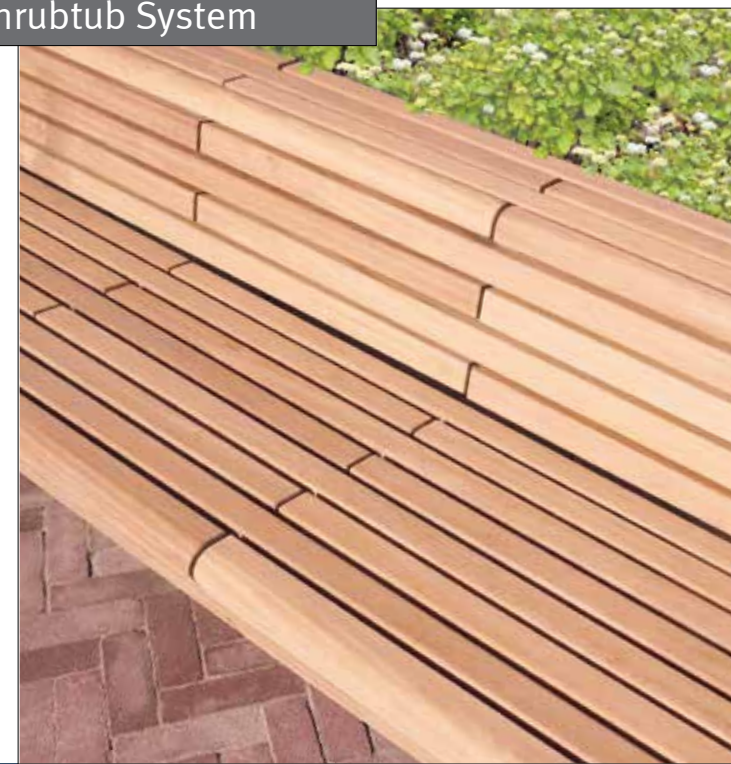





Seating can be installed alongside or on end faces using FSC® hardwood Solid slats in Streetlock® combs. Trees can also be accommodated by integrating an elevated planter unit. Photo: © Mairie de Moulins-Bourleau

Design: Streetlife  
Protected by int. Model Depots and Patents

Solid Benches  
Solid Tree Planters  
Solo Bridges

Streetlife Brochure 2018 - 2019

## Mobile Green Isle Modules

The **Mobile Green Isles** are moveable rectangular planters with integrated hardwood seats. Their basic structure is fabricated from sheet steel. With the 1.5m wide modular elements an infinite amount of designs can be created.

Seating can be installed alongside or end faces using Solid Topseats made from FSC® hardwood slats (7×7cm - 2.8”x2.8”) fitted with the stainless steel Streetlock® comb system. A seatback measuring 300cm - 118” is also available (optional). One or two trees can also be accommodated using a planter module.

The different modules available in the Mobile Green system can be combined to create countless appealing configurations. This means that every square can easily be set up to create an inviting seating area. The Streetrail® system guarantees fast and easy installation on the existing flat paved surface.

Module size 150x300x47cm - 59”x118”x19”



**MGI-PL-Module-PC**  
Low Standard Module



**MGI-LD-Module-PC**  
Low double seat-module



**MGI-HD-Module-PC**  
High double seat-module



**MGI-ES-Module-PC**  
End Module

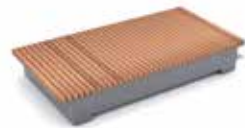

**MGI-PO-Module-PC**  
Podium Module

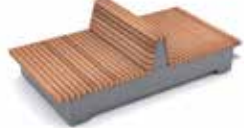

**MGI-LP-Module-PC**  
Lounge Podium



The Mobile Green Isle system is suited to flat paved surfaces. The prefab elements are installed in a matter of hours with the patented Streetrail® System. Supplied plastic rail beams are placed in line over the full length on the existing ground level according to Streetlife's instructions.





## Mobile Green Isle Surf Modules

**NEW**

Streetlife's Mobile Green Isles (MGI) enjoy great success thanks to their ability to bring green to public squares without damaging the pavement. The MGI modules (300x150cm) are very easy to position on a rail of smooth composite beams. The modules can be used to create movable green areas with border seats and platforms. Streetlife has extended the MGI system to include **Surf Modules**, which can be used to create dynamic islands for relaxation.

Module dimensions: 300x150cm - 118"x59".



The Mobile Green Isle system is suited to flat paved surfaces. The prefab elements are installed in a matter of hours with the patented Streetrail® System. Supplied plastic rail beams are placed in line over the full length on the existing ground level according to Streetlife's instructions.



**MSI-3D-300-SW-CT**  
300x150x47/67 cm  
118"x59"x19/26"



**MSI-3D-300-LW-PC**  
300x150x47/67 cm  
118"x59"x19/26"

Solid Benches  
Solid Tree Planters  
Solo Bridges  
See also:

Streetlife Brochure 2018 - 2019



The Mobile Surf Isle Modules are shown here on the University of Leipzig campus in Germany, along with Mobile Green Isles with grey coating. The contemporary design in combination with greenery creates an informal, relaxed outdoor atmosphere. Photo: © Bernd Fersterra





## Mobile Green Isle Modules Oval

**Mobile Green Isles** are also available in an **Oval** shape in which the main volume is divided between two, four or five modules depending on size.

They are moveable plant boxes with integrated hardwood seats. Their basic structure is fabricated from sheet steel. Seating can be installed alongside or at end faces using Solid Topseats made from FSC® hardwood slats (7×7cm - 2.8”x2.8”).



The Mobile Green Isle system is suited to flat paved surfaces. The prefab elements are installed in a matter of hours with the patented Streetrail® System. Supplied plastic rail beams are placed in line over the full length on the existing ground level according to Streetlife's instructions.



Solid Benches  
Solid Tree Planters  
Solo Bridges  
See also:

Streetlife Brochure 2018 - 2019



**MGI-Setup-7**  
2 x MGI-OV-PL-Module-PC + 2 x MGI-OV-LS-Module-PC  
600x300x45cm | 236”x118”x18”



**MGI-Setup-6**  
2 x MGI-OV-PL-Module-CT + 2 x MGI-OV-LS-Module-CT + 1x MGI-CW-Module-CT  
750x300x45cm | 295”x118”x18”





To the great satisfaction of citizens and shopkeepers all those involved, Amsterdam's Beethovenstraat has been upgraded with Streetlife's Podium Isles. The isles have been playfully placed around existing trees, in close consultation with the Amsterdam council designer Mirjam Lie-Wullings.

## Podium Isles

The **Podium Isles** system makes it possible to add platform seating elements to public space design. Adding to the creation of a multi-layered, lively streetscape.

Each Podium Isle is made of a CorTen steel base structure and Solid slats (7x7cm - 2.8"x2.8"), which can be fitted to a standard maximum length of 3 meters - 118" and have a gap width of 8mm - 0.31". The Isle terminates in a 7x15cm - 2.8"x5.9" end slat. The slats can be mounted in staggered rows to create islands with a width larger than 3 meters.

Tree apertures are optionally available. Placement: 15cm - 6" below ground level; does not require foundation.



Design: Streetlife  
Protected by int. Model Depots and Patents

Solid Benches  
Solid Tree Planters  
Solo Bridges

See also:

Streetlife Brochure 2018 - 2019



**PI-300-1200-CT + PI-Tree**  
1200x300x45 cm  
118"x472"x18"



**PI-300-600-CT**  
600x300x45 cm  
118"x236"x18"





## Surf Isles

**Surf Isles** were based on Streetlife's Podium Isles. Both product types use a CorTen steel base structure with Solid slats (7x7cm - 2.8"x2.8"), available at a maximum length of 300cm - 118". Compared to the clean-lined Podium Isles, the Surf Isles add a more playful element to a public space. The Isles undulating waves are available in 2D and 3D versions.

Module dimensions: 300x150cm - 118"x59"



**SI-2D-300-900-CT**  
300x900x45 cm  
118"x354"x18"



**SI-3D-300-900-CT**  
300x900x45 cm  
118"x354"x18"

Design: Streetlife  
Protected by int. Model Depots and Patents

Solid Benches  
Solid Tree Planters  
Solo Bridges  
See also:

Streetlife Brochure 2018 - 2019

Streetlife's Surf Isles were an integral part of the design for a car park redevelopment project in Halmstad, Sweden. A desolate no-man's land was transformed into a lively public space.





Design: Andropogon Associates Ltd. and Streetlife  
Protected by int. Model Depots and Patents

Solid Benches  
Solid Tree Planters  
Solo Bridges

See also:

Streetlife Brochure 2018 - 2019

## Solid Podium Discs

NEW

The **Solid Podium Discs** are circular platforms that serve as playful seating elements. The Discs feature a Solid slatted structure in multi-coloured FSC® hardwood with a red-brown colour. The sturdy edge is created from short curved-edge beams with stainless steel anti-skate elements between them. Available as movable units with forklift slots (up to a maximum of D180) or as permanent ground-level units. Dimensions: D = 180cm and 300cm - 71" and 118". Designed in close collaboration with Andropogon Associates Ltd. The photos were taken on the renovated Drexel Quad in University City, Philadelphia.



**SOL-PDI-D180-PC**  
180/160x47 cm  
71"/63"x19"



**SOL-PDI-D300-CT**  
300/280x47 cm  
118"/110"x19"



**SOL-PDI-D300-PC**  
300/280x47 cm  
118"/110"x19"





## Solid Terrace Curve

The **Solid Terrace Curve** is a striking element allowing for the creation of recreational spaces with excellent seating capacity in flexible formations. The raised seat provides a good view of the surroundings and is sure to appeal to young people in particular. The seat and the upright backrest components consist of Solid slats of FSC®-100% hardwood. The base structure comprises modular CorTen steel components. Streetlife supplies the complete system, which can easily be installed by third parties.

Dimensioning is project-based and carried out in collaboration with the client's specifications. Contact us to find out about the possibilities.

Slats 7x7cm - 2.8"x2.8" (seating)  
3,5x7cm - 1.4"x2.8" (cladding)



Design: Streetlife  
Protected by int. Model Depots and Patents

See also:  
Solid Benches  
Solid Tree Planters  
Solo Bridges

Streetlife Brochure 2018 - 2019



## Solid Terrace System

The **Solid Terrace System** consists of self-supporting slat modules by means of which exceptional and tiered constructions can be realized. The FSC® hardwood slats are invisibly mounted in a special version of the patented Streetlock® comb fittings. The space between the slats is only 8 mm - 0.3". They are suitable for horizontal as well as vertical assembly on a prefab supporting structure. Streetlife supplies the complete system, which can easily be installed by third parties.

Slats 7x7cm - 2.8"x2.8" (seating)  
3,5x7cm - 1.4"x2.8" (cladding)  
Length 180, 200, 234 & 300cm - 71"/79"/92"/118"

Upon presentation of a simple sketch with the general dimensions, Streetlife will be happy to give advice and make an attractive, engagement-free price indication.



Design: Streetlife  
Protected by int. Model Depots and Patents

See also:  
Solid Benches  
Solid Tree Planters  
Solo Bridges

Streetlife Brochure 2018 - 2019







## Solid Edge System

The **Solid Edge System** is a simple way to create rising borders with Solid seats. It makes for a pleasant spot to sit shaded by the accompanying greenery.

The steel base structure is available RAL-coated or in CorTen. The front wall slopes back steeply to create leg space. Side walls at 70°, 90°, 110° or as an extension of the seating edges are optional. The Solid Top Seats are available with 6 slats (46cm - 18"), 8 slats (62cm - 24") or 12 slats (93cm - 36"). The sturdy hardwood slats are mounted from above using Streetlock® comb fittings.



Solid Benches  
Solid Tree Planters  
Solo Bridges

See also:



From a flat surface, one can easily create green sloping surfaces with Solid sitting edges at heights of ± 47cm. The side panels are to be placed under multiple angles.



The addition of the Solid Edge System and Solid Picnic Tables to the Science Centre in Philadelphia is a quick and effective way to upgrade a side street to a high-quality green street with seating and places to eat lunch. By: Andropogon Landscape Architects.





#### **First Avenue, NYC**

These flamboyant bench arrangements were designed by Scape Landscape Architecture DPC and realised in close collaboration with Streetlife. The bespoke project consists of four unique configurations and was inspired by the Solid Edge System, which features broad, sloping backrests. An extra-high border is perfect for including luxuriant vegetation. Streetlife supplied the prefab modules along with detailed installation directions for the local building contractor. The modules have been installed on the plaza in front of the new Copper Building in Manhattan.





Design: Streetlife  
Protected by int. Model Depots and Patents

Rough&Ready Benches  
Rough&Ready Green Benches  
Rough&Ready Tree Planters  
Rough&Ready Bicycle Parking  
See also:

Streetlife Brochure 2018 - 2019

## Circular Tree Isles

The **Circular Tree Isles** have a diameter of three, four or five metres. The tree isles consist of CorTen steel sections with a Rough&Ready sitting edge of FSC®-100% hardwood (beams 7x15cm - 2.8"x5.9"). The beams are positioned radially, offering a natural anti-skate solution.

The unique tree isles are completely stand-alone on the concrete deck or are embedded in the ground. Large trees can be anchored underground by a specially developed foundation construction. The construction does not require separate foundation. The depth below ground level depends on the particular project in question and is determined by the height of the ground level construction. The standard depth is 15cm - 6".

The continuous Rough&Ready border seat is beautifully integrated with the CorTen steel structure. By using the patented Streetlock® fix-and-replace System, the beams can be easily replaced. Ideal in the event of damage!



Circular Tree Isles	BE-D300	BE-D400	BE-D500
outer diameter	300 cm - 118"	400 cm - 157"	500 cm - 197"
sitting depth	40 cm - 16"	50 cm - 20"	50 cm - 20"
sitting height	45 cm - 18"	45 cm - 18"	45 cm - 18"
internal height	variable	variable	variable
substrate	3,5-5 m³	7-10 m³	12-15 m³
substrate	ca. 1.700 kg/m³	ca. 1.700 kg/m³	ca. 1.700 kg/m³
length full bench 360° (Q4)	± 9,7 m - 30 ft	± 12,5 m - 41 ft	± 15,7 m - 52 ft
weight hardware	ca. 750 kg	ca. 1050 kg	ca. 1250 kg
length of half bench 180° (Q2)	± 4,7 m - 15 ft	± 6,2 m - 20 ft	± 7,8 m - 26 ft
weight hardware	ca. 470 kg	ca. 650 kg	ca. 830 kg
length quarter bench 90° (Q1)	± 2,25 m - 7½ ft	± 3,1 m - 10 ft	± 3,9 m - 13 ft
weight hardware	ca. 330 kg	ca. 450 kg	ca. 600 kg



TI-D300-40-Q4



TI-D300-40-Q2



TI-D300-40-Q1

The Circular Tree Isles have standard external diameters of two, four or five metres. Larger diameters can be custom-made on request. This project is located in Middelharnis (NL), in co-operation with Kuiper Compagnons.





## Oval Tree Isles

Large public spaces require proportionally larger interventions. **Oval Tree Isles** measure a minimum of 9m - 30 ft in length and approximately 4m - 13 ft in width, perfect for making vast spaces more welcoming. An outer radius of at least 3m - 10ft is required to install border seating along the short ends of an isle. R&R beams are positioned radially to prevent skateboarders from skating along seat edges.

The CorTen steel structures do not require their own foundation – standard depth below ground level is 15cm - 6”. A cambered fill allows trees with larger root balls to be planted. Larger trees should be securely anchored using a special-purpose sub-soil support system. Tree isles can be aesthetically implemented using permeable drainage strip around their CorTen steel walls.

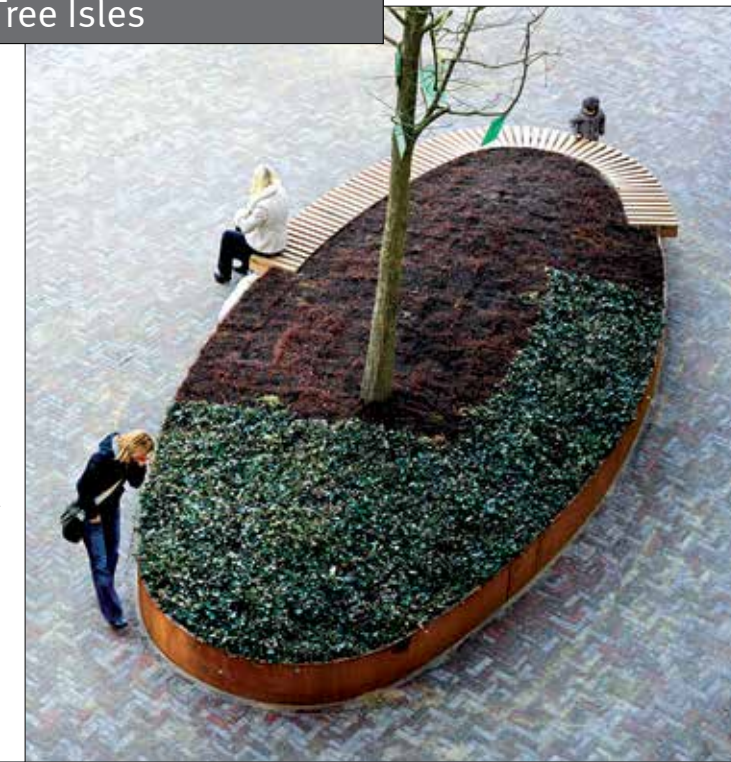

Design: Streetlife  
Protected by int. Model Depots and Patents

Rough&Ready Benches  
Rough&Ready Green Benches  
Rough&Ready Tree Planters  
Rough&Ready Bicycle Parking

See also:

Streetlife Brochure 2018 - 2019

The Oval Tree Isles at the Batavia Stad Outlet Shopping Centre, Lelystad, the Netherlands, feature a CorTen steel construction and seating on the two short sides. The CorTen steel is also used in the Conical Shrubtubs placed at the shop entrances.





Design: Streetlife  
Protected by int. Model Depots and Patents

Rough&Ready Benches  
Rough&Ready Green Benches  
Rough&Ready Tree Planters  
Rough&Ready Bicycle Parking

See also:

Streetlife Brochure 2018 - 2019

## Bento Tree Boxes

A natural landscape also looks attractive in geometrical forms, for which we recommend the **Bento Tree Boxes**. The integrated Rough&Ready sitting edges of these islands are straight and have a depth of around 100cm - 39". Other dimensions can be realized in consultation with Streetlife. The Bento Tree Boxes can be ordered in CorTen and in grey coated steel.

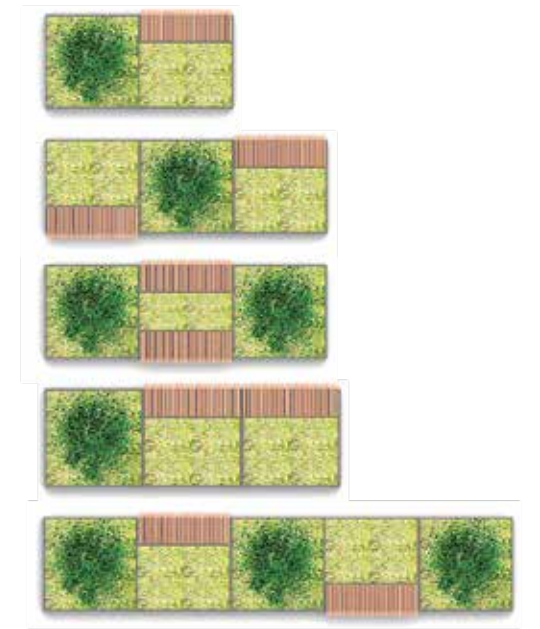
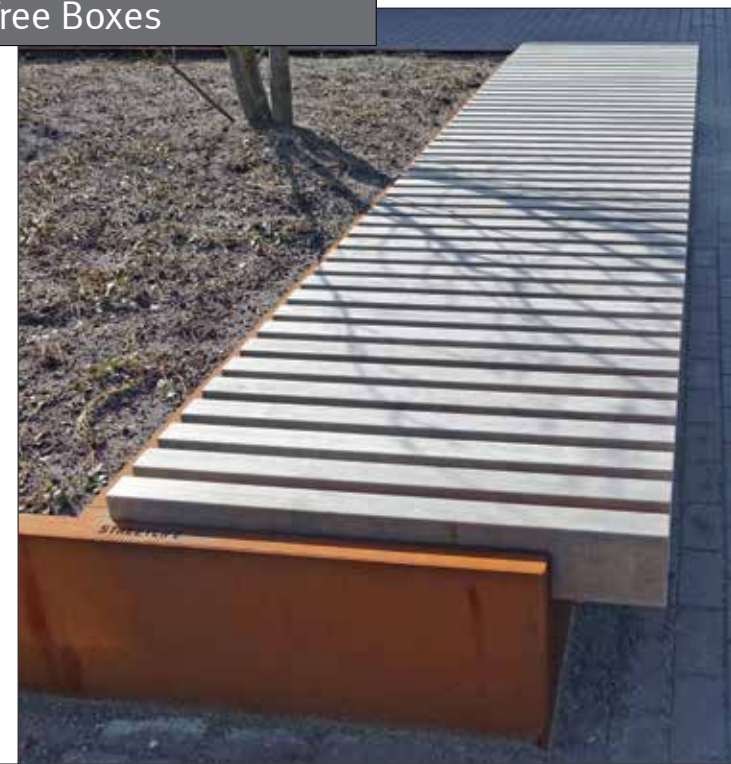





This integral design for the Geleenstraat in Heerlen, the Netherlands, features various custom products. Galvanised steel and wood are the basic elements of this new plan. Galvanised steel is included in the isles, a bespoke tree grid, and the supports for the circular bench.

Design: Streetlife  
Protected by int. Model Depots and Patents

Rough&Ready Benches  
Rough&Ready Green Benches  
Rough&Ready Tree Planters  
Rough&Ready Bicycle Parking

See also:

Streetlife Brochure 2018 - 2019

## Free Form Tree Isles

Many shapes can be created with the **Tree Isles System**. In order to integrate a Rough&Ready border seat, a diameter of at least three metres is required. Based on a sketch with main dimensions, our advisors will gladly provide you with a non-obligatory proposal.

These images illustrate various options using Streetlife's Tree and Seating Isles in a variety of shapes and designs. Larger trees can be securely anchored using a special-purpose sub-soil support system and illuminated using recessed Tree Air® spotlights.

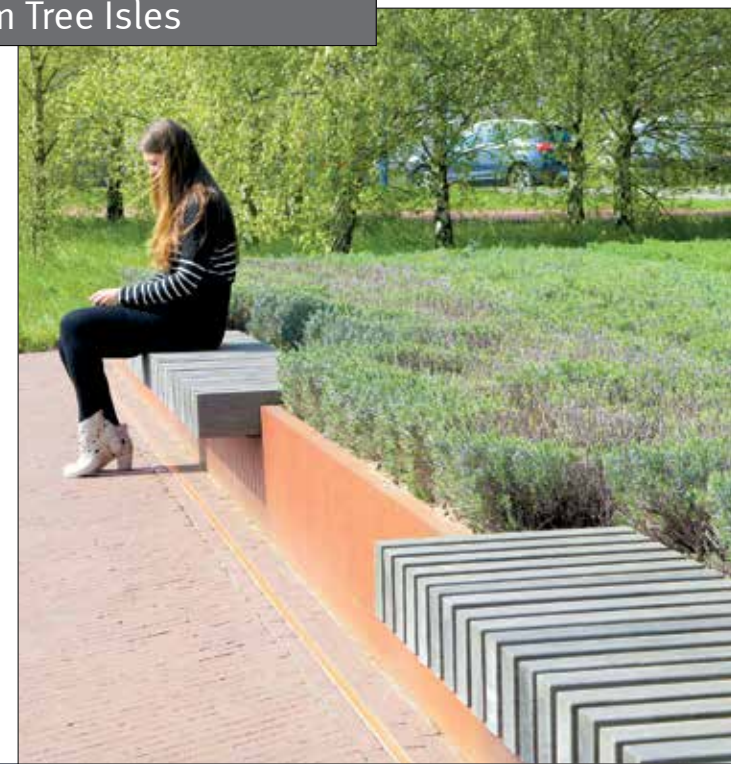





Index



Solid Tree Planters  
202



Highlife (Serpentine) Planters **NEW**  
204



Rough&Ready Basic Planters  
206



Shrubtubs Cylindrical  
212



Shrubtubs Conical  
214



Globe Planters  
218



Tumbling Tubs **NEW**  
220



Ultra Light Tubs  
222



Shrubtubs Square  
208



Shrubtubs Square  
211



Synthetic Cones  
224



Giant Flower Pots  
228



Giant Flower Pots  
230



Love Tubs  
232



Tone Tubs  
234

Category 4  
**Tree Planters**  
- TreeTec®  
- Planters





## Trees on the move

Streetlife has gained extensive experience in professional tree planters and Treetec® care systems as a result of many years of close partnership with leading tree specialists. We even have a new Nordic version available for very cold climates.

Our contemporary and innovative solutions continue the centuries-old tradition of the Orangery and Hortus Botanicus in terms of both aesthetics and techniques. The optimum care and nurture of the trees are the central elements of this development.

Reasons to place trees in tree tubs:

- Shortage of sufficient underground space, as is the case with underground car parks, roof gardens, areas with existing underground services, and high groundwater levels.
- It allows a large degree of flexibility and multifunctionality.
- Movable large trees do not require tree-felling permission.
- They are unnoticeably defensive, with the ability to act as a roadblock in front of important buildings and streets.
- For an interesting and alternative way to build up design layers within an urban plan.

Streetlife's new Collection includes various tree planters and other solutions for combining sustainable greenery and recreation; Green Benches (Cat. 3) are one such option. Ultra-lightweight tree planters – with or without seating options and/or sustainable decking materials – provide architects with numerous tools to create attractive green spaces in even the most sensitive of locations.

Existing trees in an urban environment are not left out in our Tree Collection. CorTen tree grids, tree guards and tree and growing space protectors (Cat. 5) complete Streetlife's full and coherent range of products.



Our great inspiration is the pomegranate tree at Slot Herrenhausen in Hanover. This plant came to North Germany from Venice in 1653, and has survived the turbulent history of this region right down to the present. This tree is in perfect health thanks to 350 years of optimal care and attention in a planter.





## Tree Tub Technology

Years of research and experience with countless urban projects have resulted in the Treetec® system which is applied in Streetlife's tree tubs. Streetlife collaborates with alliance partner BSI Bomenservice BV in projects involving sustainable and urban greenery. The Treetec® tree care system enables trees in tree tubs to develop properly. In this way, you can apply sustainable greenery and urban trees in any urban location, building, parking decks, viaduct or roof terrace.

The Treetec® wall construction ensures sufficient thermal insulation and prevents damaging variations in temperature. As well as water, trees also require a sufficient supply of oxygen to their roots. The Treetec® wall construction ensures oxygen circulation around the root ball from the inside of the tub.

Each Streetlife tree tub has facilities to fix small and large root balls in the tree tub. This invisible root ball anchoring prevents any lopsided growth of the tree.

Every Streetlife tree tub is designed in such a way that the tub and the tree are easily relocated. Depending on the size of the tree tub, this can be easily done with a fork-lift truck or with a crane (with standard counterweights or hoisting band set). One should calculate 1700kg per m<sup>3</sup> with a damp substrate.

Trees in tubs require a measured composition of the substrate. We have had success using a compound of potting compost and sand supplemented with additives. We recommend using ground covering, e.g. ivy matting or tree grids. Green ground covering creates an aesthetically appealing effect, insulates the soil's top surface, and prevents it from drying out and dirt from accumulating.

Dense urban landscapes have an increasing need for sustainable shrubbery and landscaping in more obscure places such as on deck patios and roofs. However, these structures are often limited to a maximum uniformly distributed load of 500 kg/m<sup>2</sup>. Using lightweight decking and planters filled with a low-density substrate provides an affordable and sustainable way to plant trees on roofs. High-rise buildings are subject to high wind loads. Once tree types and planters have been selected, Streetlife can provide advice about wind load calculations based on statistical assumptions for various tree types.

Treetec® Basic, Treetec® Bottom Up and Nordic® system are standardized tree care systems that can be integrated with Streetlife's range of professional tree planters. Treetec® systems ensure adequate insulation, oxygen circulation, root ball fixing, irrigation and excess water drainage. Capillary tubes in the Treetec® kit provide improved water circulation that significantly reduces the frequency with which watering and maintenance are required in the growing season.

Please see overleaf for Treetec® schematic diagrams and specifications. Treetec® systems and Streetlife tree planters are intellectual property protected by filed patents and designs. Several factors determine whether trees grow successfully in a planter, e.g. tree type, substrate, maintenance, pruning and watering. We've made a Tree Table to help you get started.



## Roadblocks

These days, increasingly strict requirements are applied to protect strategic (government) buildings and public spaces. The complete safe shielding of buildings, preventing ram raids and attacks, is considered high priority. However, anti-ram barriers often appear damaging to the prestige of a building or with a pleasing architectural style that conveys accessibility.

Extra heavy-duty steel tree planters with additional ground level anchoring/foundation form attractive and budget-friendly elements that can serve as anti-ram **Roadblocks**. With proper integration of the tree planters, friendly-looking accessibility can be combined with optimal safety.

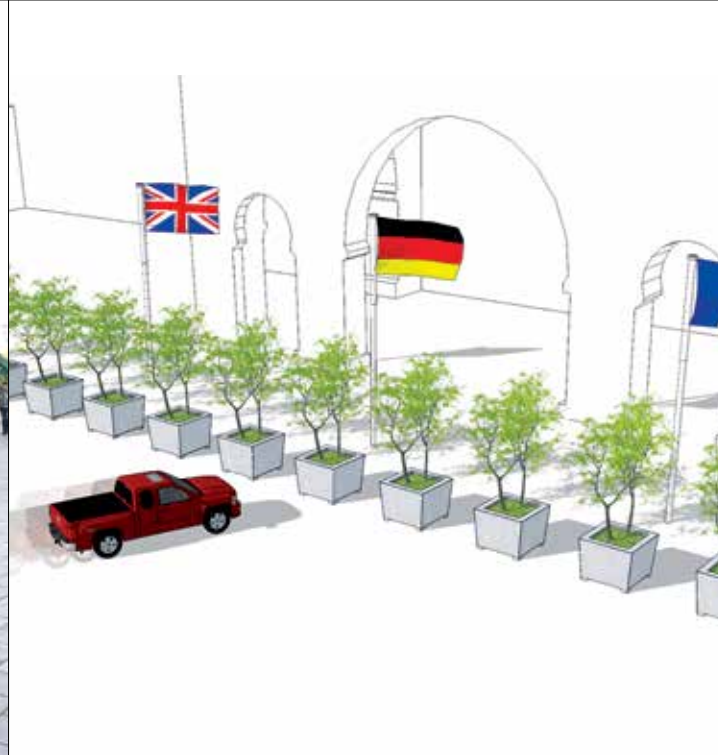

## Treetec System®

### Treetec® Bottom Up

With Treetec® Bottom Up, the water reservoir is situated at the bottom of the tree tub or tree isle. Vertical capillary tubes circulate water to the roots. The reservoir's capillary tubes provide improved water circulation that significantly reduces the frequency with which watering and maintenance are required in the growing season.

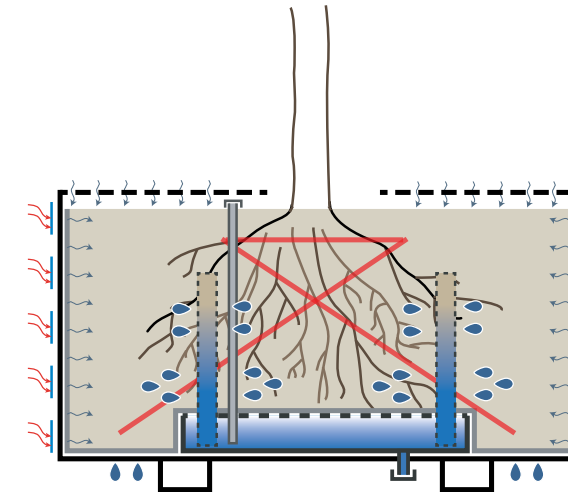

**TREETEC® BOTTOM UP**, like Treetec® Basic (1 t/m 4):

5. Integrated water reservoir at the bottom.
6. The water reservoir can be filled up via an inlet.
7. Capillary columns distribute the water around the roots. In the course of time, the roots will accommodate the capillary columns and will absorb the water as needed.



### Treetec® Basic

Treetec® Basic is a basic care kit for ensuring healthy growth in tree planters. The kit consists of an oxygen circulation system, thermal insulation and sub-soil root ball fixing system.

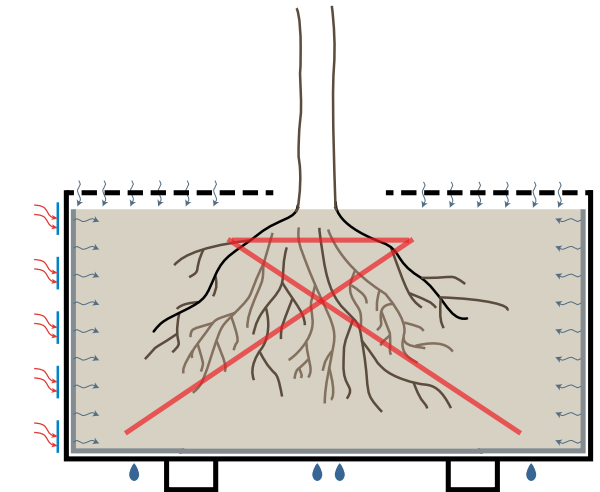

**TREETEC® BASIC:**

1. Wall construction: thermal insulation and oxygen circulation around the root ball.
2. Optional covering using tree grids or green ground matting reduces the rate of evaporation thereby preventing soil from drying out.
3. Tree-root anchoring that prevents lopsided growth.
4. Excess water due to heavy rainfall does not accumulate but is drained off via the bottom.



## Treetable for the Tree Tubs

An appropriate choice from the available assortment is an essential part of a project. Trees are often available in an unexpected form, such as multi-stemmed, low-branched or in pollarded form. Tree specialists provide advice in this context. In conjunction with the client and landscaping specialists, future success is guaranteed.

### LEGEND CODES

- G Large tub, size: 200 x 200 x 90 cm (l x b x h)
- M Medium tub, size: 170 x 170 x 90 cm (l x b x h)
- K Small tub, size: 140 x 140 x 90 cm (l x b x h)
  
- L Lee, for a spot sheltered from the wind
- B Flowering
- Vd Fruit-bearing
- Kl Climber, trellis needed
- L/V Suitable for training (trellis) or shaped tree
- H Autumn colour
- W Ornamental value in the winter
- S Shrub

### TREE SPECIES

### CODES

Abutilon pictum 'Thompsonii'	M K L B	Gleditsia triacanthos 'Skyline'	G M L
Acer campestre 'Elsrijk'	G M L/V	Gleditsia triacanthos 'Sunburst'	G M L
Acer platanoides 'Deborah'	G M H	Hydrangea arborescens 'Annabelle'	K L B S
Acer saccharinum	G L H	Ilex meservae 'Blue Princess'	M K B Vd W S
Aesculus carnea 'Briotii'	G B	Koelreuteria paniculata	M K B Vd
Aesculus parviflora	M K L B	Kolkwitzia amabilis	K B S
Albizia julibrissin 'Rosea'	M K L B	Liquidambar styraciflua	M L H W
Amelanchier lamarckii	M K B Vd H S	Magnolia kobus	M K B
Aucuba japonica 'Variegata'	K B Vd W S	Magnolia stellata	M K B
Betula typen	G	Malus 'Evereste'	M K B Vd
Broussonetia papyrifera	K L B Vd	Morus alba 'Macrophylla'	G M L
Buddleja davidii 'White Profusion'	K L B S	Nothofagus Antarctica	G M K H W
Camellia japonica	M K L B S	Parrotia persica	M K
Carpinus betulus	G M K L/V	Photinia fraseri 'Red Robin'	M K B H W
Cassia marylandica	K L B K I S	Phyllostachys aureosulcata 'Aureocaulis'	G M W
Cercidiphyllum japonicum	M K H	Pinus sylvestris	G M W
Cercis siliquastrum	M K B H	Plantanus x acerifolia 'Tremonia'	G M L
Chamaerops humilis	G M K L W	Plantus orientalis 'Digitata'	G M
Cornus alba 'Sibirica'	K B Vd H	Populus tremula 'Erecta'	M K
Cornus kousa	K B Vd H	Prunus cerasifera 'Nigra'	M K B
Corylus colurna	G Vd	Prunus laurocerasus var.	M K W
Corinus coggigria 'Royal purple'	M K S	Prunus sargentii	M
Davidia involucrata	G B	Prunus subhirtella 'Autumnalis'	M K B W
Decaisnea fargesii	M W S	Pyrus typen	M K B
Eucalyptus gunnii	M L	Quercus robur	G M Vd
Euonymus alatus	M K H W S	Quercus rubra	G Vd
Fagus sylvatica 'Dawyck'	G M H	Syringa typen	G M B S
Fatsihedera lizei	K L B W S	Sophora japonica	G M B
Fatsia japonica	K L B W S	Taxus baccata	G M K L/V W
Ficus carica	K L B	Tilia europaea 'Pallida'	G M K L/V
Fraxinus angustifolia 'Raywood'	G L	Vitis typen	K B Vd K I S
Fraxinus ornus	G M L	Wisteria typen	K B K I S

## Multi-stemmed Trees



Amelanchier lamarckii © Ebben



Taxus baccata © Ebben



**Multi-stemmed and shaped trees** have a sculptural character. Due to their expansion breadth-wise, they create plenty of shade. The accompanying examples are very suitable for our tree tubs. However, the best choice of trees is a matter for the experts. Tree specialists will be pleased to advise you.

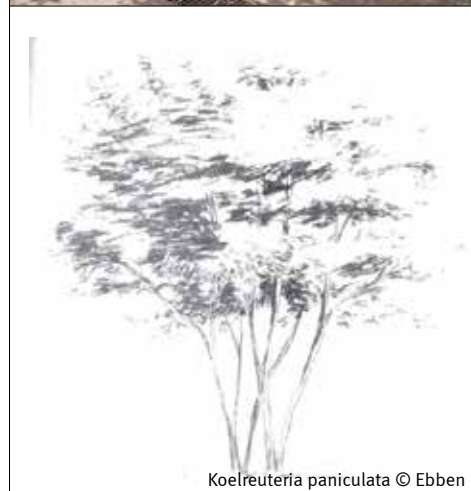

Koelreuteria paniculata © Ebben



Acer © Ebben





Design: Streetlife  
Protected by int. Model Depots and Patents

Solid Benches  
Mobile Green Isles  
Solo Bridges  
See also:

Streetlife Brochure 2018 - 2019

## Solid Tree Planters



**SOL-PL-D150-104**  
Ø150x104, ± 1,1m³  
Ø59"x41", ± 39 cu ft

**SOL-PL-D220-81**  
Ø220x81, ± 2,2m³  
Ø87"x3-2", ± 78 cu ft



**SOL-PL-S150-90**  
150x150x90, ± 1,3m³  
59"x59"x35", ± 46 cu ft



**SOL-PL-S200-90**  
200x200x90, ± 2,7m³  
79"x79"x35", ± 95 cu ft



**SOL-PL-S250-90**  
250x250x90, ± 4m³  
98"x98"x35", ± 141 cu ft



Solid slats have been placed vertically on the **Solid Tree Planters**. The FSC® hardwood Solid slats (7x7cm - 3"x3") form a robust, characteristic edge on the top end of the tub. The Tree Tubs are part of the Solid product range and therefore combine well with other Solid products. The facilities for the Tretec® Bottom Up System have been beautifully integrated in the composite inner tub. Available in round and square designs up to an impressive dimension of 250x250cm - 98"x98" with a substrate volume of approximately 4m³ - 141 cu ft.

Streetlife recommends using the Tretec® Bottom Up system in these stunning tree planters.

Solid Tree Tubs are distinct due to their bold wooden edging. The top ends of the Solid slats measure 7x7cm. By incorporating the Tretec® Bottom Up System, trees can grow to their full potential.





Design: Streetlife  
Protected by int. Model Depots and Patents

Highlife Benches  
Highlife Picnic Sets

See also:

Streetlife Brochure 2018 - 2019

## Highlife III Tree Planters

**NEW**



**HLF-PL-SRP-200-200-90**  
210x195x90, ± 1,85m³  
82"x77"x35", ± 65 cu ft



**HLF-PL-S150-90**  
150x150x90, ± 2m³  
59"x59"x35", ± 71 cu ft



**HLF-PL-S200-90**  
200x200x90, ± 2,7m³  
79"x79"x35", ± 95 cu ft

**Highlife III Tree Planters** create a warm, elegant streetscape. The Highlife III style features a contemporary, graphic character. The alternating slat design is created FSC® hardwood in three different widths. The slats are 38mm thick. A black metal frame creates a chic edge.

The square Highlife III Tree Planters have a composite inner tub and are finished with a multi-coloured FSC® hardwood alternating slat design. Three different sizes: 150x150cm, 170x170cm and 200x200cm - 59"x59", 55"x55"en 79"x79".

The new **Serpentine Tubs** with an organic design use the narrow slats in the inner curves. The tree planters can be easily integrated with the comfortable Highlife III Benches and other Highlife III street furniture. Larger models are suitable for trees measuring between 8 and 10m - 26 and 33 ft in height. Dimensions: 210x195x90cm - 82"x77"x35".

Streetlife recommends using the Treetec® Bottom Up system in these stunning tree planters.



Some 40 Highlife Tree Tubs measuring 250x250cm with a substrate volume of approximately 5m³ have been placed on Symphonyplein in Amsterdam. The black metal edge gives the tubs a chic appearance and protects the top ends of the Highlife slats. A lively greenscape has emerged over a two-year period to form a mobile park on top of the underground car park.





Design: Streetlife  
Protected by int. Model Depots and Patents

Rough&Ready Benches  
Rough&Ready Tree Isles  
Rough&Ready Bicycle Parking

See also:

Streetlife Brochure 2018 - 2019

## Rough&Ready Basic Tree Planters



**R&R-PL-Basic-S150-90**  
150x150x90, ± 2m³  
59"x59"x35", ± 71 cu ft



**R&R-PL-S170-90-AB**  
170x170x90, ± 2,5m³  
67"x67"x35", ± 88 cu ft



**R&R-PL-Basic-S200-90**  
200x200x90, ± 3m³  
79"x79"x35", ± 106 cu ft



**R&R-PL-S240-90**  
240x240x90, ± 5,2m³  
94"x94"x35", ± 184 cu ft

**Rough&Ready Basic Planters** consist of a metal structure, finished with solid R&R hardwood beams measuring 7×15cm - 3"x6" along the top and bottom edges. These beams are made from 100% FSC® hardwood or black recycled plastic (All Black). These R&R beams can be combined with galvanized steel, CorTen or RAL coated plate construction. These R&R Basic Planters can be optionally fitted with the Treetec® Bottom Up system.

The **Rough&Ready Tree Planters** are part of our successful R&R Range, which consists of over forty different products. The coherence of the various Rough& Ready products is unprecedented, in part due to the use of a single, substantial modular wood size, rigorous spacing and consistent detailing. Rough&Ready is sturdy and robust, uses sustainable materials and creates a contemporary appearance.



The Rough&Ready Basic Tub is part of the R&R product range of sturdy, robust street furniture. The photograph below was taken in Amsterdam and shows an R&R-10 bench configuration with an R&R Basic Tub in matching heights. The steel structure was coated in a brown colour.





Design: Streetlife  
Protected by int. Model Depots and Patents

See also: Huga Tub

Streetlife Brochure 2018 - 2019

## Shrubtubs Square



**STUB-PL-S90-90-CT**  
90x90x90, ± 0,7m³  
35"x35"x35", ± 25 cu ft



**STUB-PL-90-180-90-CT**  
90x180x90, ± 1,35m³  
35"x71"x35", ± 48 cu ft



**STUB-PL-S150-90-PC**  
150x150x90, ± 1,85m³  
59"x59"x35", ± 65 cu ft



**STUB-PL-S200-90-CT**  
200x200x90, ± 3,3m³  
79"x79"x35", ± 117 cu ft

These **Shrubtubs Square** and Tree Tubs are normally made of 4mm - 0.15" thick CorTen steel. They contain a volume of substrate up to a maximum of 5m³ - 177 cu ft. and are suitable for shrubs, multi-stemmed trees. Bigger city trees depend on this substrate volume. The Tretec® Bottom Up nursing system is optional.

The CorTen tub is well detailed, functional and available with a special double powdercoating. The Shrubtubs can be easily relocated and have anchoring for the root ball. The single-walled sides are reinforced to prevent sagging due to soil pressure.

The Tretec® Bottom Up system ensures adequate insulation, oxygen circulation, root ball fixing, irrigation and excess water drainage.







In memory of the 21 people who lost their lives at the 2010 Love Parade, 21 young magnolias planted in CorTen Shrubtubs have been placed in front of the train station in Duisburg. The square Shrubtubs have been positioned symmetrically on the station square. The minimalist design and configuration are of symbolic value and help create a place to reflect and remember.

Design: Streetlife  
Protected by int. Model Depots and Patents

See also: Huga Tub

Streetlife Brochure 2018 - 2019

## Shrubtubs Square



The **Shrubtubs DB Grau** steel tree planters are available in a range of double powdercoated colours. Selecting and applying a coating system requires specialist knowledge. The choice of colour has a major influence on the product's life expectancy and the treatment required to deal with any damage, e.g. scratches.

Almost all Streetlife tree planters are manufactured from heavy gauge sheet metal with sleek detailing. The tree planters can be ordered in Corten Colour in addition to unfinished warm CorTen steel. A special powder coating for CorTen steel is available in a range of RAL colours. If the planter is scratched while in use, the steel underneath won't rust – it will just turn slightly darker.

Shrubtubs in **DB Grau** colour are placed at Frankfurt airport, Germany. Dull outdoor areas can be made more appealing by combining multi-stemmed trees or large shrubs in interesting configurations.

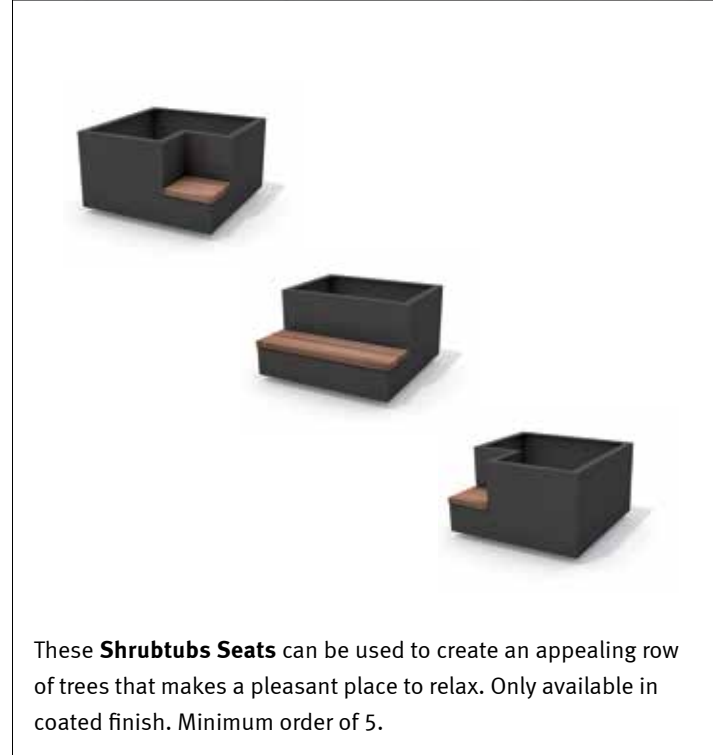

These **Shrubtubs Seats** can be used to create an appealing row of trees that makes a pleasant place to relax. Only available in coated finish. Minimum order of 5.







Design: Streetlife  
Protected by int. Model Depots and Patents

## Shrubtubs Cylindrical

These **Shrubtubs Cylindrical** are made of 4mm-gauge CorTen steel. Just like the Shrubtubs Square, they are equipped with a wide, clean-lined edge that gives extra reinforcement and is appealing to the eye. Streetlife recommends equipping these tree planters with the Treetec® Bottom Up tree care system. The CorTen tree planters have a clean design and are also available with a RAL-coating. These Shrubtubs can be easily moved and have integrated anchor points for the tree root ball.



**STUB-PL-D90-75-CT**  
Ø90x75, ± 0,45m³  
Ø35"x30", ± 16 cu ft



**STUB-PL-D90-90-CT**  
Ø90x90, ± 0,55m³  
Ø35"x35", ± 19 cu ft



**STUB-PL-D150-90-PC**  
Ø150x90, ± 1,5m³  
Ø59"x35", ± 53 cu ft



**STUB-PL-D200-90-CT**  
Ø200x90, ± 2,8m³  
Ø79"x35", ± 99 cu ft



Streetlife Brochure 2018 - 2019

With their rectangular shape, Shrubtubs are particularly suited to creating clean-lined cityscape designs. The Cylindrical Shrubtubs, however, are more suited to playful designs. They quickly create an informal atmosphere in an urban area.





Design: Streetlife  
Protected by int. Model Depots and Patents

## Shrubtubs Conical

These **Shrubtubs Conical** are available in various diameters and three heights. They are made of CorTen steel, which naturally weathers creating a protective patina layer that makes it extremely durable and suitable for public space.

If required, they can be finished in a RAL colour, double-layered powdercoating. Streetlife advises users of these mobile conical tubs to install the Treetec® Bottom-up system.

The corresponding plant dishes (H=45cm - 18") are also available.



**CON-PL-D180-90-CT**  
Ø180x90, ± 1,7m³ | Ø71"x35", ± 60 cu ft

**CON-PL-D150-90-CT**  
Ø150x90, ± 1,2m³ | Ø59"x35", ± 42 cu ft

**CON-PL-D120-90-CT**  
Ø47"x35", ± 26 cu ft | Ø120x90, ± 0,7m³

**CON-PL-D145-45-CT**  
Ø145x45, ± 0,7m³ | Ø57"x18", ± 26 cu ft





Design: Streetlife  
Protected by int. Model Depots and Patents

## Shrubtubs Conical

These **Shrubtubs Conical** are available in various diameters and three heights. They are made of CorTen steel, which naturally weathers creating a protective patina layer that makes it extremely durable and suitable for public space.

If required, they can be finished in a RAL colour, double-layered powdercoating. Streetlife advises users of these mobile conical tubs to install the Treetec® Bottom-up system.

Corresponding plant dishes (H=45cm - 18") are also available.

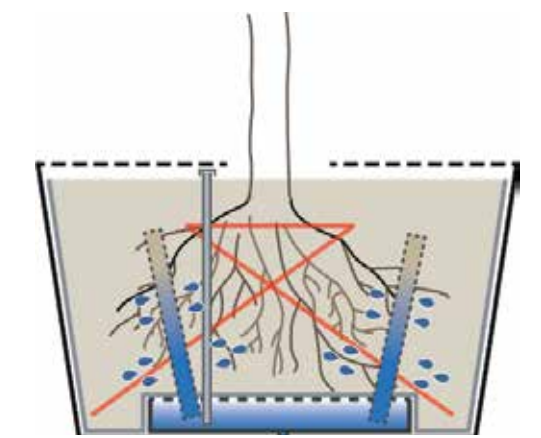
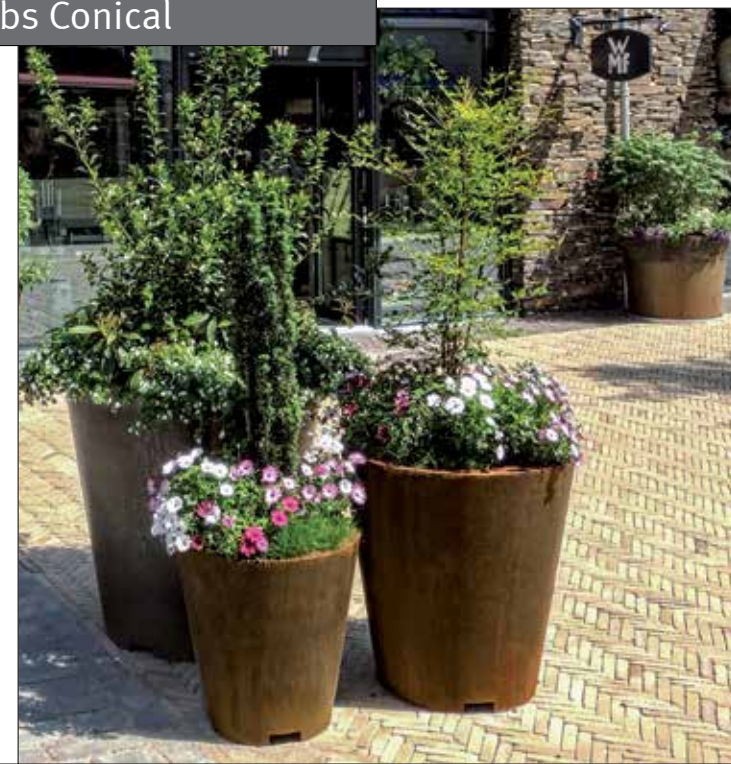

The Treetec® Bottom Up system ensures adequate insulation, oxygen circulation, root ball fixing, irrigation and excess water drainage.

Streetlife Brochure 2018 - 2019





Design: Streetlife  
Protected by int. Model Depots and Patents

## Globe Tree Planters

**Globe Tree Planters** are geometric spheres made of CorTen steel that create a playful, unusual streetscape. If required, they can be finished in a RAL colour, double-layered powdercoating. The smaller versions comprise half a sphere. The tubs have been meticulously finished with a wide, continuous edge in CorTen steel. We recommend that the Treetec® Bottom Up System is applied in combination with sculptural multi-stemmed trees.

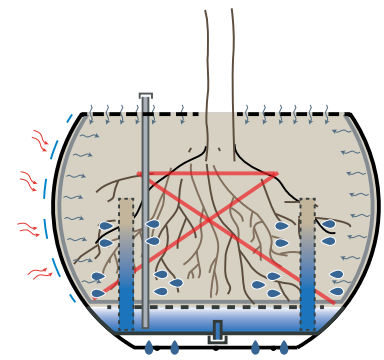

**GL-PL-D160-110-CO**  
Ø160x110, ± 1,5m³  
Ø63"x43", ± 63 cu ft

**GL-PL-D160-73-CO**  
Ø160x73, ± 0,7m³  
Ø63"x29", ± 25 cu ft

**GL-PL-D160-110-CT**  
Ø160x110, ± 1,5m³  
Ø63"x43", ± 63 cu ft





Design: Streetlife  
Protected by int. Model Depots and Patents

The **Tumbling Tubs** are intriguing CorTen plant boxes, conical in shape with a round base. They can be positioned at a slight angle (max 5°) using a steel base ring. This creates a playful effect that shows off flowering plants in particular to their best advantage. Tumbling Tubs are 160cm or 120cm in diameter, available in a high (90cm - 35") and a low (50cm - 20") planter height.

Streetlife advises TheTreetec® Bottom Up system: this system ensures adequate insulation, oxygen circulation, root ball fixing, irrigation and excess water drainage.

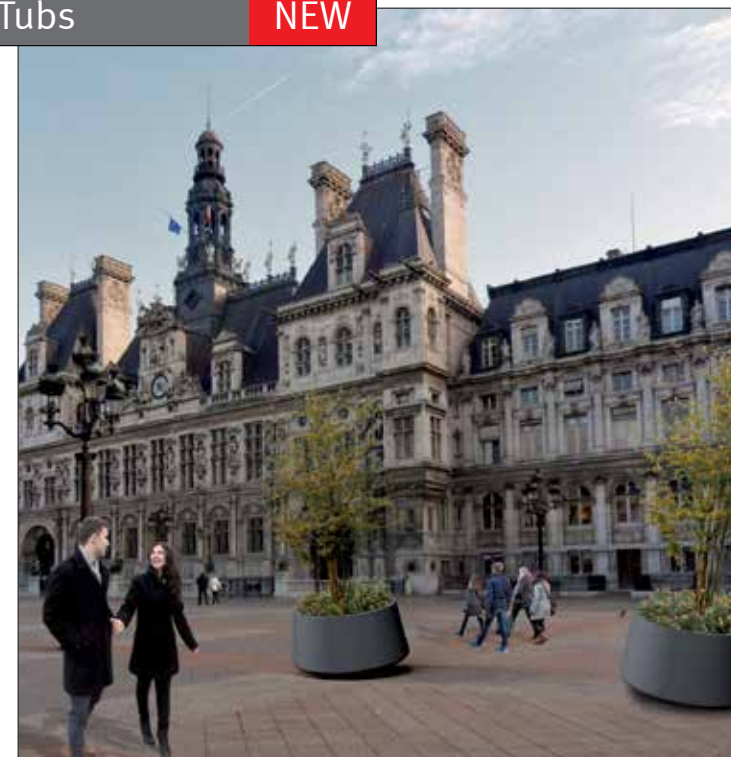
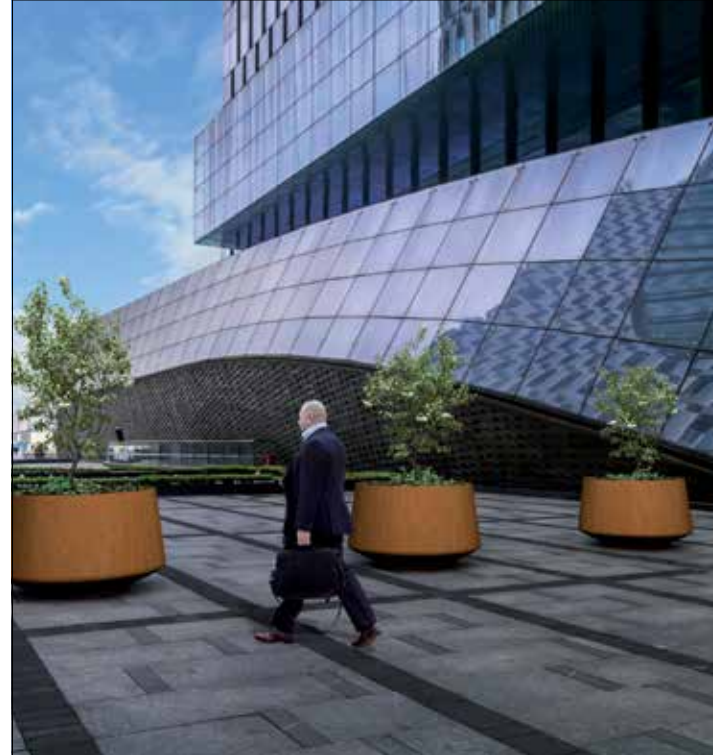

## Tumbling Tubs

**NEW**



**TUMB-PL-V-D120-50-CT**  
Ø120/114x50, ± 0,45m³  
Ø47\*/45"x20", ± 16 cu ft



**TUMB-PL-A-D160-50-CT**  
Ø160/153x50, ± 0,65m³  
Ø63\*/60"x20", ± 23 cu ft



**TUMB-PL-A-D120-90-CT**  
Ø120/100x90, ± 0,8m³  
Ø47\*/39"x35", ± 28 cu ft



**TUMB-PL-V-D160-90-CT**  
Ø160/140x90, ± 1,4m³  
Ø63\*/55"x35", ± 49 cu ft

Streetlife Brochure 2018 - 2019



## Ultra Light Tubs



**Ultra Light Tubs** in combination with a low-density substrate have been specifically designed for use on roof terraces and deck patios that often have limited uniformly distributed load-bearing capacities.

It is possible to create low-maintenance, recreational roof gardens/terraces simply and effectively using Ultra Light Tubs or Air Tubs and Synthetic Cones in combination with sustainable Streetdeck®40 decking or Sedum coffer.

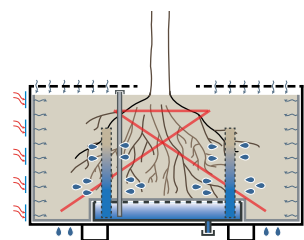

Design: Streetlife  
Protected by int. Model Deposits and Patents

See also: Solid Air Tubs

Streetlife Brochure 2018 - 2019

## Ultra Light Tubs

These **Ultra Light Tubs** are made of partly recycled Aluminium Composite plate material. In combination with a lightweight substratum, the lightweight shrub and tree tubs are extremely suitable for roofs. Ultra Light Tubs can be placed directly onto deck patio surfaces. An even load of 500 to 600 kg/m<sup>2</sup> is feasible with these tubs. Streetlife advises the application of the optional Tretec® Bottom Up system in the tubs. The capillary columns ensure a better distribution of the water, which substantially reduces the frequency of water maintenance. Over time, Ultra Light Tubs become matter in appearance. They are finely detailed, attractively austere and also available in a RAL colour. According to preference, they are available with a broad edge (tree outline) or an internal tree grid profile. On the interior, thick geo-textile ought to be applied for insulation.

Micro-peen finish available at additional cost.



Design: Streetlife  
Protected by int. Model Deposits and Patents

See also: Solid Air Tubs

Streetlife Brochure 2018 - 2019



**ULTUB-PL-S75-75-AL**  
75x75x75, ± 0,42m<sup>3</sup>  
30"x30"x30", ± 15 cu ft

**ULTUB-PL-S90-90-AL**  
90x90x90, ± 0,7m<sup>3</sup>  
35"x35"x35", ± 25 cu ft



**ULTUB-PL-75-150-75-AL**  
75x150x75, ± 0,8m<sup>3</sup>  
30"x59"x30", ± 28 cu ft



**ULTUB-PL-S150-90-AL**  
150x150x90, ± 2m<sup>3</sup>  
59"x59"x35", ± 71 cu ft



## Synthetic Cones



**SC-PL-D160-155-CO**  
 Ø160x155, ± 2m³  
 Ø63"x61", ± 71 cu ft



**SC-PL-D140-110-CO**  
 Ø140x110, ± 1,3m³  
 Ø55"x43", ± 46 cu ft



**SC-PL-D140-75-CO**  
 Ø140x75, ± 0,7m³  
 Ø55"x29", ± 25 cu ft



**SC-PL-D160-75-CO**  
 Ø160x75, ± 1m³  
 Ø63"x30", ± 35 cu ft

Design: Streetlife  
 Protected by int. Model Deposits and Patents

Streetlife Brochure 2018 - 2019

## Synthetic Cones

**Synthetic Cones** are thick-walled, insulating plastic mouldings. The eco-friendly plastic used has a terrazzo look and feel. Fun layouts can be created by mixing cones available in diameters of 140 and 160cm - 55" and 63", and five different heights. Large Synthetic Cones are suitable for trees measuring up to approximately 6m in height. The Treetec® Bottom Up system can only be used in cones measuring 110 and 155cm - 43" and 61" in height.

Extra long capillary tubes are available for the largest cone (Ø160cm - Ø63", height 155cm - 61"). See Treetec® Bottom Up System.



Design: Streetlife  
 Protected by int. Model Deposits and Patents

Streetlife Brochure 2018 - 2019

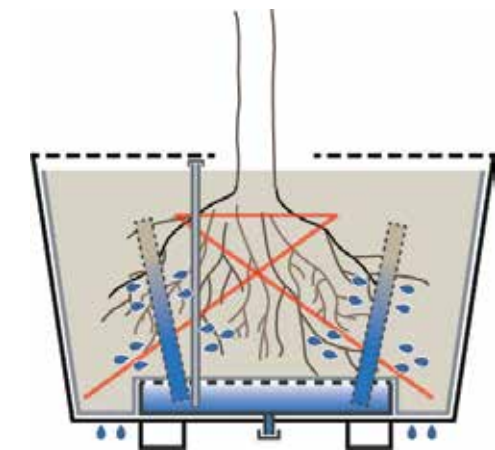

The Treetec® Bottom Up system ensures adequate insulation, oxygen circulation, root ball fixing, irrigation and excess water drainage.



# Synthetic Cones

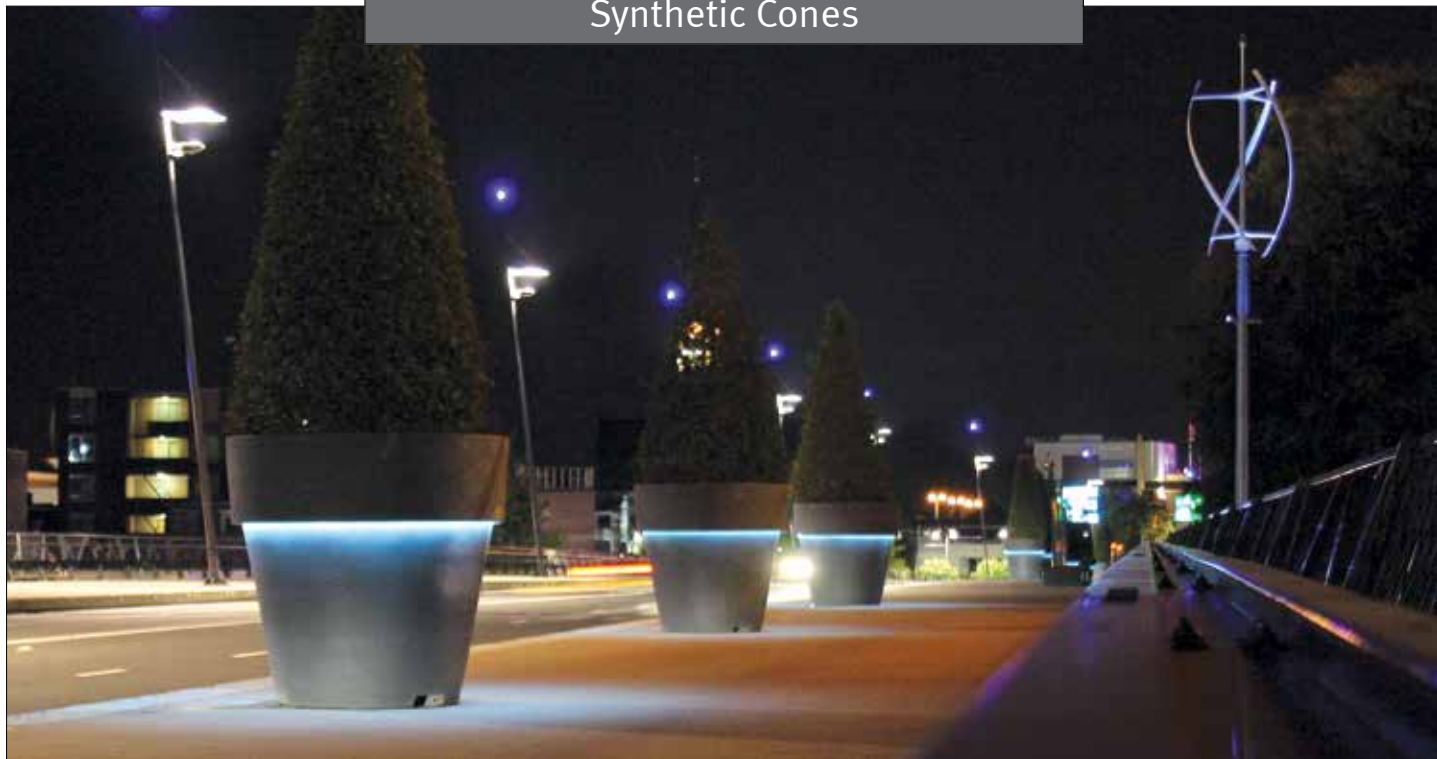

Design: Streetlife  
Protected by int. Model Depots and Patents



Traffic Red, uni color



White Granito, from recycled plastic



Brown, with Natural Fibres



Streetlife Brochure 2018 - 2019

# Synthetic Cones



Black Granito

Anthracite Granito

Medium Grey Granito



Streetlife Brochure 2018 - 2019

The tall Synthetic Cone is LED-Ready. It is advisable to include a pipe sleeve/casing in the Cone for the LED line.

The Synthetic Cones are available in three sizes and are made of a thick-walled, insulating moulded plastic or natural fibre. The eco-friendly material has a terrazzo feel and look. These Cones offer affordable and durable green solutions and are available in six colours. All planters feature drainage holes and fork lift provisions for easy installation and long term maintenance. We advise the Synthetic Cones in combination with our Treetec® Bottom Up system.

White Granito is realised by mixing white with transparent recycled plastic, which generates a very attractive texture.

The Brown Natural Fibres is a material realised by mixing plastic with approximately 30% hay fibres from locally mown and dried grass. The fibres remain visible, which generates a vivid brown colour with a beautiful texture.

Custom colours are available for a minimum order of 20 units.





Design: Streetlife  
Protected by int. Model Depots and Patents

## Giant Flower Pots

**Giant Flower Pots** are available in a sustainable natural fibre-reinforced composite material. The Natural Fibres consist of thick natural fibre mats, which are soaked with resin by means of the Resin Transfer Moulding process. The fibres are completely sealed, yet remain visible. The composite rim and lower part of the pot require assembly on site.

Available in two colours: Rusty Brown and Light Grey.

Natural Fibre models are more expensive than models finished in RAL colours.



Light Grey Natural Fibres



Rusty Brown Natural Fibres



**GFP-PL-D240-47-NF**  
Ø240x47, ± 1m³  
Ø94"x19", ± 35 cu ft

**GFP-PL-D240-120-NF**  
Ø240x120, ± 3,5m³  
Ø94"x47", ± 124 cu ft

Streetlife Brochure 2018 - 2019





Design: Streetlife  
Protected by int. Model Depots and Patents

## Giant Flower Pots

The **Giant Flowerpots**, or large-format conical tubs are available in two sizes: Ø215 and Ø240 cm - Ø85" and Ø94". They are made from steel, double powder-coated in a RAL colour or sustainable composite material, where the gel coating has a RAL colour. This variant is identical in size to the others, but is lighter and less expensive. The composite rim and lower part of the pot require assembly on site. The pots can be easily relocated. Depending on the volume of the substrate, they are suitable for trees up to 8 metres tall. The Tretec® Bottom Up system is an optional extra.

Giant Flower Pots are also available in a low type. Their wide-brimmed edge functions perfectly as seating. They are made of a composite material that acts like an insulator just like wood, creating a comfortable seating area.



**GFP-PL-D240-47-CO**  
Ø240x47, ± 1m³  
Ø94"x19", ± 35 cu ft



**GFP-PL-D240-120-CO**  
Ø240x120, ± 3,5m³  
Ø94"x47", ± 124 cu ft

In Ghent, the urban planning agency BUUR has temporarily landscaped various city centre locations with our Giant Flowerpots. Displaying bright red and purple colours, both high and low flowerpots accentuate the design of these temporary landscapes as the area awaits renovation.

Streetlife Brochure 2018 - 2019





On the Spuiplein in The Hague, Streetlife realized a project with fourteen large Love Tubs with exchange tubs. Tubs have been personalized with The Hague City Council kite logo. Shrubbery is changed each season.

## Love Tubs

The **Love Tubs** are made out of brushed 316 Stainless- or CorTen Steel. They have a tapered, square shape. All corners are seamless and smooth. The Love Tubs with a capacity of 1.25 to 2.5m<sup>3</sup> - 44 to 88 cu ft are suitable for trees 5 to 6m tall. Multi-stemmed trees create a splendidly full image. The tubs can be equipped with the Treetec® Bottom Up system if required. The Love Tubs are also available in a lower variant (H = 45cm - 18"). In larger projects, the planters can be equipped with stainless steel letters or a lasered logo.

The Love Tubs have a rich allure and combine well with modern architecture. Weighting or anchoring the Love Tubs enables them to be used as Road Blocks at the main entrances or glass façades of important buildings, as at the head office of the Port of Rotterdam.

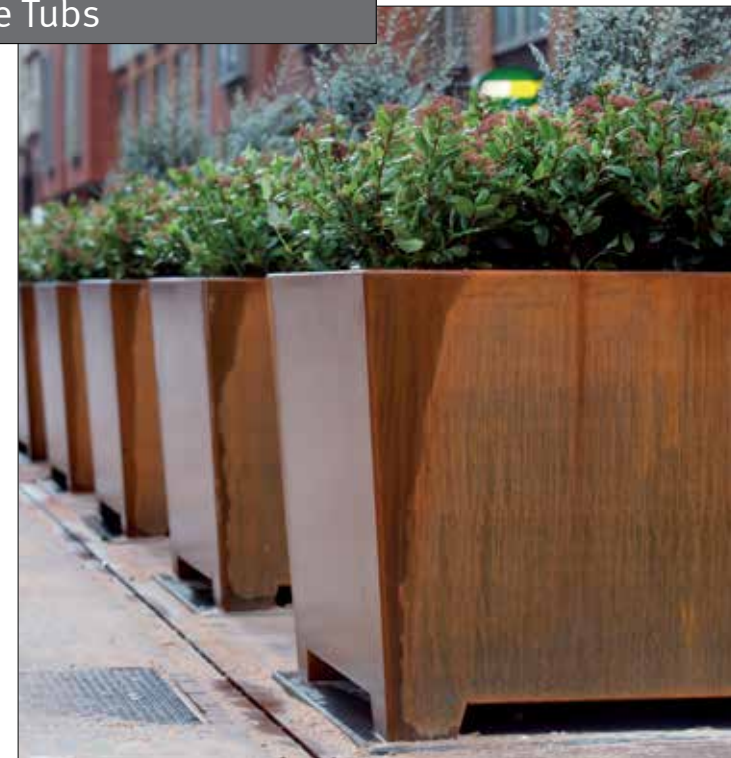

Design: Piotr Ostojski-Ostaja  
Protected by int. Model Depots and Patents

Streetlife Brochure 2018 - 2019





Elegant Tone Tubs dot the French city of Metz. They have been RAL-coated in light grey. Metz (FR) Ask our consultants about the three special Earth colours available for the Tone Tubs!

Design: Streetlife  
Protected by int. Model Depots and Patents

Streetlife Brochure 2018 - 2019

## Tone Tubs



**TTUB-PL-S110-100-AL-PC Dark Green**  
110×110×100, ± 1m³  
Ø43"x43"x39", ± 35 cu ft



**TTUB-PL-S130-120-AL-PC Light Grey**  
130×130×120, ± 1,5m³  
Ø51"x51"x47", ± 53 cu ft



**TTUB-PL-S110-100-AL-PC Red Earth**  
110×110×100, ± 1m³  
Ø43"x43"x39", ± 35 cu ft



**TTUB-PL-S130-120-AL-PC Light Grey**  
130×130×120, ± 1,5m³  
Ø51"x51"x47", ± 53 cu ft



**TTUB-PL-S110-100-AL-PC Light Grey**  
110×110×100, ± 1m³  
Ø43"x43"x39", ± 35 cu ft



**TTUB-PL-S130-120-AL-PC Light Grey**  
130×130×120, ± 1,5m³  
Ø51"x51"x47", ± 53 cu ft



The **Tone Tubs** are made of Aluminium plate and are double powdercoated in RAL colour on the outside. These tapered, square tree planters are particularly elegantly designed and can be equipped with the Treetec® system on request. These tree tubs are attractively austere and well detailed. They can be easily relocated and have internal anchorage points for the root ball. Available in 3 exceptionally subtle earth colours of RAL colours.







Category 5  
**Tree Grilles & Guards**

- Tree Grilles
- Press Grating
- Tree Guards
- Tree Outlines
- Cortile System

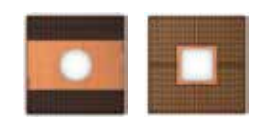

CorTen Press Gratings **NEW**  
 244



Tree Grilles Round **NEW**  
 246



Tree Grilles Square **NEW**  
 248



Tree Grilles Extra Fine  
 250



Cortile System **NEW**  
 254

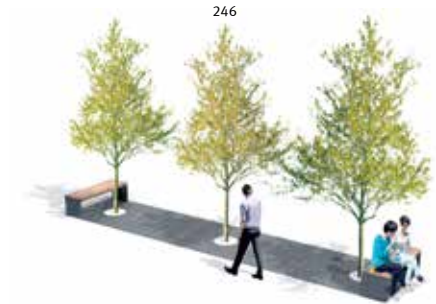

Tree Grille Strips  
 252



Tree Guards  
 258



Tree Outlines  
 266

On Justus Lipsius Square in Leuven, Belgium, CorTen Tree Grille Strips are combined with randomly placed R&R Cubes and R&R Crosswise Benches. The CorTen Strips in “Bamboo” pattern connect the multi-trunk trees and allow extra oxygen migration.





## CorTen steel Tree Grills and Tree Guards

Thick-walled CorTen steel is a sustainable material, making it ideal for tree grids which have to cope with various sorts of traffic every day. Streetlife is a specialist supplier of **CorTen steel Tree Grills and Tree Guards** with various innovative detailed solutions. We offer a selection of standard products to choose from and are also happy to design and develop customised solutions in consultation with you.

Corten steel is the perfect material to use in public space with its natural properties, durability and low maintenance, warm colour and high environmental qualities adding to the attractiveness of natural and urban surroundings. CorTen steel can be applied outdoors without any unfriendly treatment such as zinc or chemical coatings. CorTen is a steel alloy with added chromium, copper and nickel on which, after having been exposed to the elements for about six months, a dense, water and air-tight patina of rust will appear, which will prevent the steel from rusting any further.

Streetlife supplies various products in CorTen steel. Apart from its warm look, CorTen steel has a number of advantages: it is environmentally friendly, graffiti and sticker-resistant, shows an attractive fading effect from orange to brown and due to its natural oxidation, any repairs or alterations to a CorTen steel structure will become invisible in time.

To optimally protect tree and trunk from unnecessary damage, we offer several models of unique CorTen tree guards. The universal Guardlock® System ensures a beautifully detailed and solid mounting of guard to grid, without the fixings being visible. Streetlife tree grids are available in various natural and contemporary **graphic patterns**. The grids come in square, round and strip formats, while our Tree Outlines made of rolled carbon steel complete this line of products.

Do you have a different idea in mind for a project? Streetlife will gladly provide you with a customised solution.

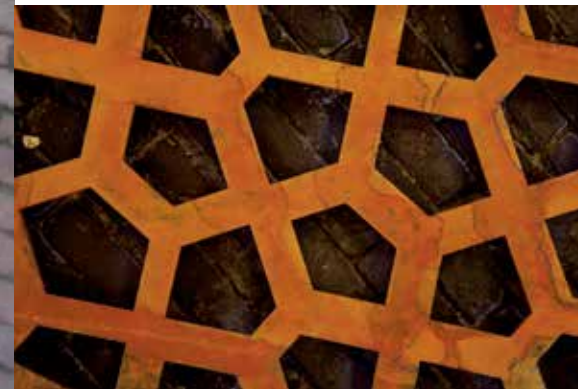



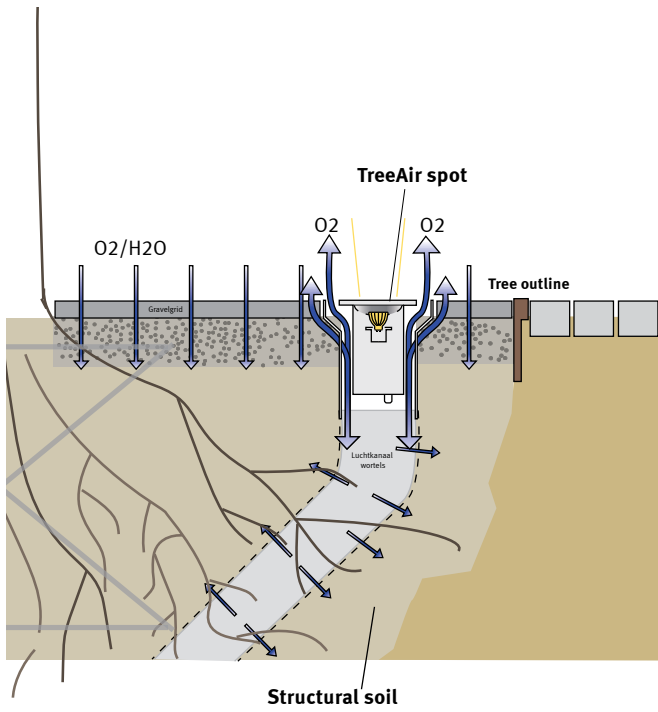

## Tree Air® Spot

Streetlife now supplies a unique recessed spotlight incorporating the Tree Air® root aeration system (patent pending) that can be combined simply and effectively with CorTen steel tree grids and large tree planters. Heat generated by the spotlight establishes an additional airflow into the aeration channels if the channel is left open along one side. This system does away with the need for separate air grilles resulting in a neat and tidy finish. Also available in LED version.

TG-AirSpot-D18, CDM-TM 20 Watt 830, 1650 Lumen with connecting piece

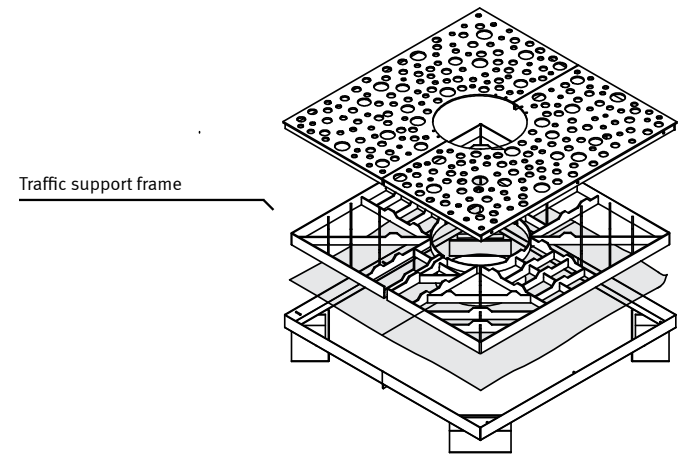
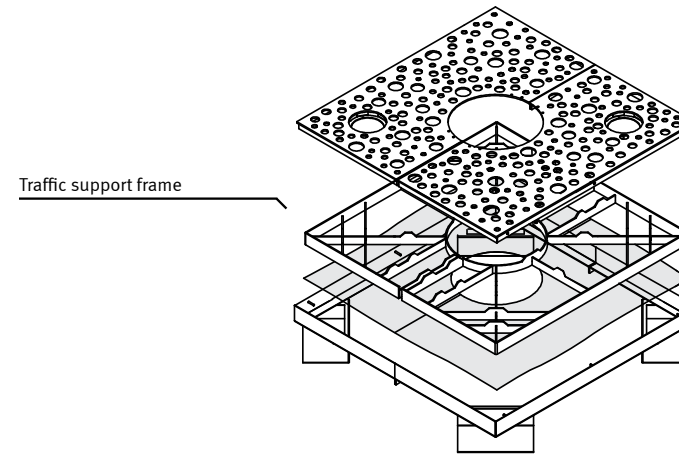
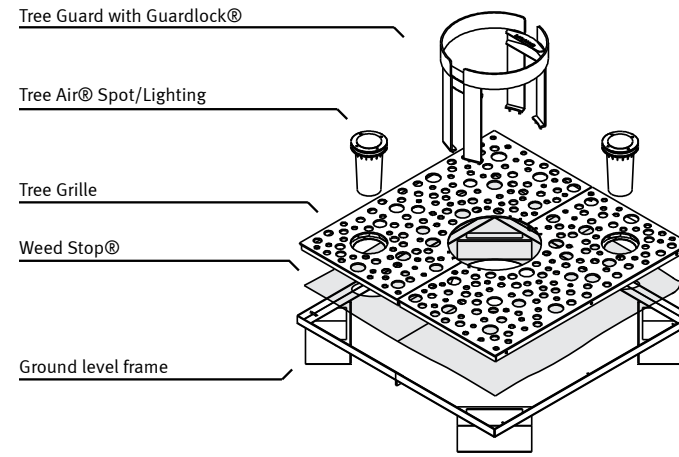
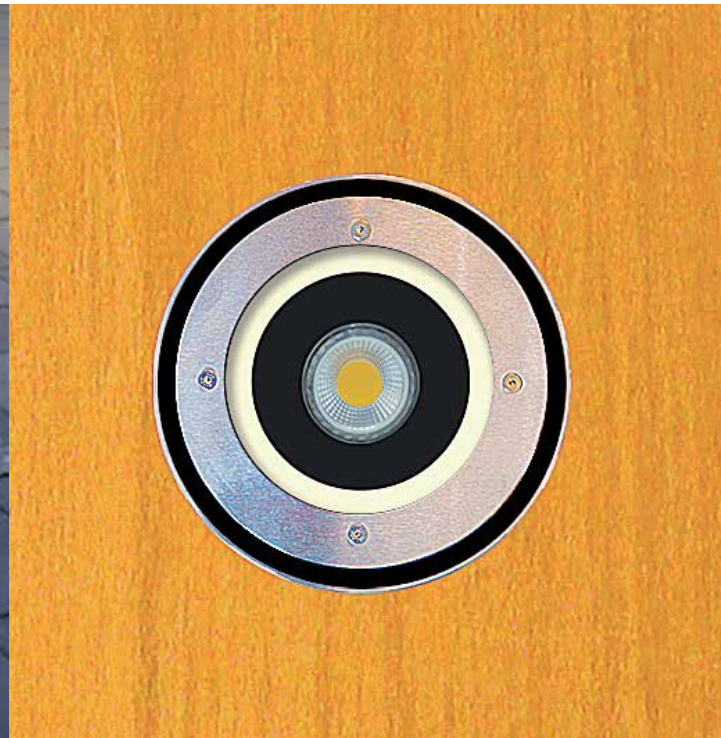

## CorTen Tree Grids - Traffic Classification

Depending on the available budget and the desired traffic class, a tree grid can be fitted with a simple outline or a reinforcement/foundation frame. Outlines and frames are all high-end CorTen constructions, which means that the whole structure is made of sustainable mono-material. An underlying filter, the Weed Stop® Solution, can be optionally integrated to prevent undesired weed growth through the air slots in the grid. The accompanying isometric drawings further explain the system layout.

Our advisors have sound technical expertise, so please do not hesitate to contact them with your questions.

Traffic Classification:	Max.	in kg	in Newton	Per tire	Max. load*
Traffic Class. A	1,5 ton	1.500 kg	15 KN	nvt	1.500 kg
Traffic Class. B	10 ton	10.000 kg	100 KN	50 KN	5.000 kg
Traffic Class. C	15 ton	15.000 kg	150 KN	75 KN	7.500 kg

\* On minimal 20x20 cm surface





**Sound**  
120 cm x 120 cm

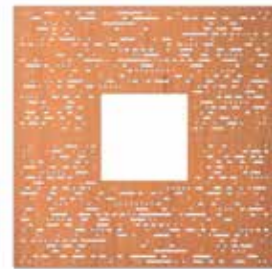

**Sound**  
150 cm x 150 cm



**Sound**  
180 cm x 180 cm

Design: Streetlife  
Protected by int. Model Depots and Patents

Streetlife Brochure 2018 - 2019



Streetlife's **Tree Grille product range** is available in a variety of organic and modern patterns lasered into heavy gauge CorTen steel. They are available for different traffic categories. The 2018-2019 Collection features two new graphic patterns:

- **Sound**, for rectangular grids – in three sizes, with square tree holes.
  - **Ants**, for round grids – in three sizes, with round tree holes.
- Ants meets the American ADA standards.

Dimensions: 120cm, 150cm and 180cm.

Design: Streetlife  
Protected by int. Model Depots and Patents

Streetlife Brochure 2018 - 2019



**Ants**  
120 cm x 120 cm



**Ants**  
150 cm x 150 cm



**Ants**  
180 cm x 180 cm



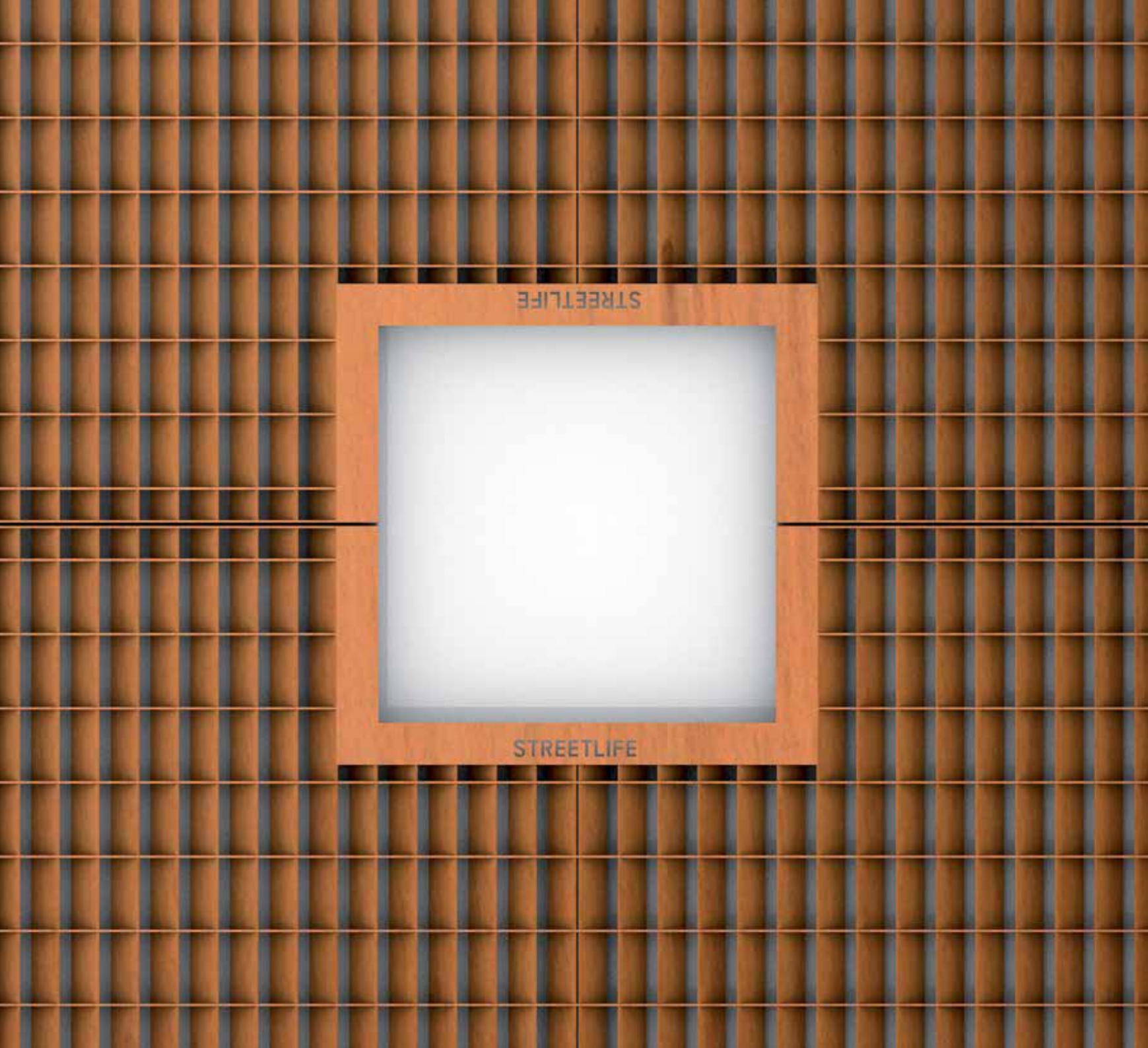

## CorTen Press Grating

**NEW**

The Tree Grille product range is being expanded to include **CorTen Press Grating Grilles** constructed from CorTen steel strips. Three types are available:

- **Transparent:** with a small mesh size (approx. 50x17mm) and a square or round tree hole
- **Lucent:** with a small mesh size (75x15mm), a heavy gauge CorTen centre plate and a round tree hole.
- **Wave:** with a mesh size of 93x50mm and a square tree hole. The grid strips are fixed at a 45° angle. The Wave is available up to a maximum of 120cm wide.

The Press Grating Grilles are available in the three standard sizes of 120x120cm, 150x150cm and 180x180cm. They are suitable for pedestrian areas with the standard characteristics. The Lucent and Transparent models are also available in traffic category B.

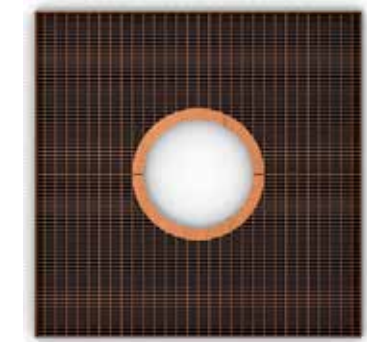

**PGR-TRA-S120-CT**  
Transparent

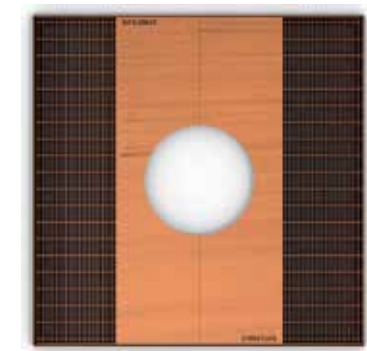

**PGR-LUC-S120-CT**  
Lucent

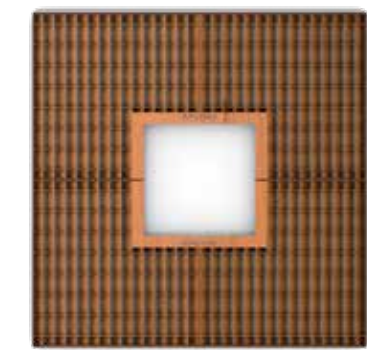

**PGR-WAV-S120-CT**  
Wave

### Tree Guards



New Tree Guard: Outline





These round Twigg Tree Grilles feature an organic pattern of abstracted twigs. The pattern alternates between deep impressions and cutouts, creating a detailed multi-dimensional image.

Design: Streetlife  
Protected by int. Model Depots and Patents

See also: Box Bins

Streetlife Brochure 2018 - 2019

## Tree Grilles CorTen Round



Casual Dots

Thick-walled **Tree Grilles CorTen Round** are available in a wide range of patterns - square or round. The diameter of the aperture always measures a third of the grille's overall width, e.g. ø33 and ø60cm - 13" and 24" in 100 and 180cm - 39" and 71" wide grilles respectively. We recommend CorTen steel frames when installing tree grilles at ground-level in order to provide adequate support and to maintain uniformity with street paving.

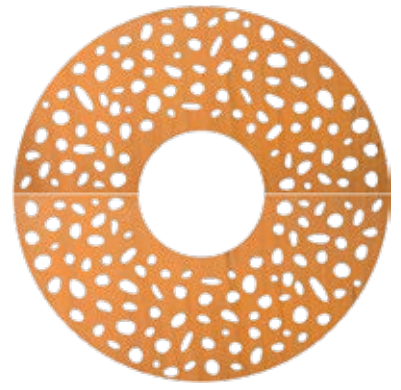

Pebbles



Cloud of Nuts

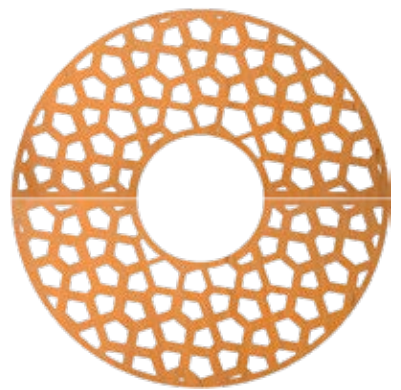

Magic



Ripple



Twigg



Kiwi





Design: Streetlife  
Protected by int. Model Depots and Patents

See also: Box Bins

Streetlife Brochure 2018 - 2019

## Tree Grilles CorTen Square

Thick-walled **Tree Grilles CorTen Square** are available in a wide range of patterns - square or round. The diameter of the aperture always measures a third of the grille's overall width, e.g. ø33 and ø60cm - 13" and 24" in 100 and 180cm - 39" and 71" wide grilles respectively. We recommend CorTen steel frames when installing tree grilles at ground-level in order to provide adequate support and to maintain uniformity with street paving.

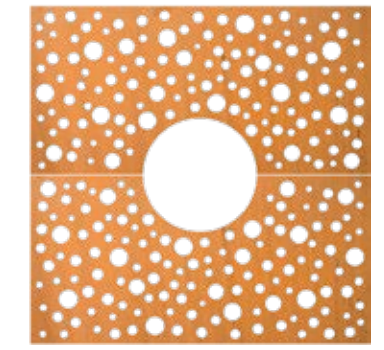

Casual Dots

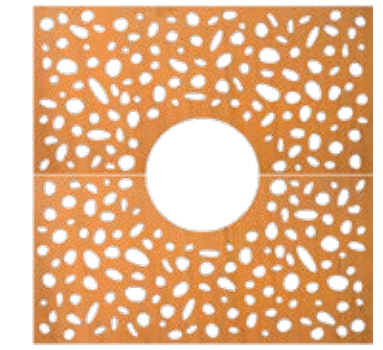

Pebbles



Cloud of Nuts

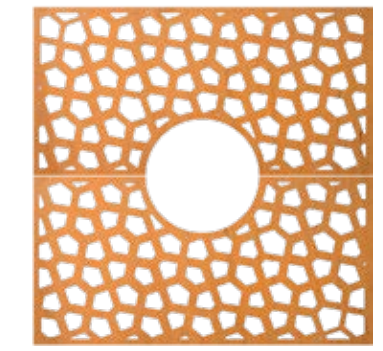

Magic



Ripple

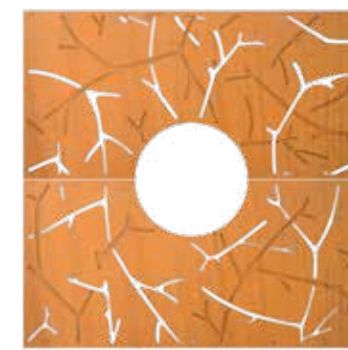

Twiggy

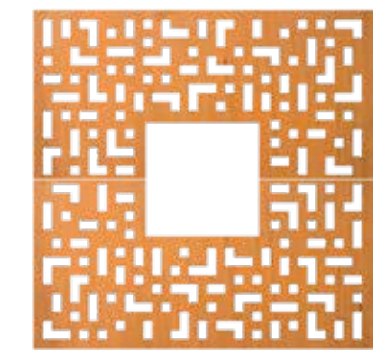

Matrix

The range of graphic patterns in Streetlife's Tree Grids are inspired by nature and modernism. On these square grilles featuring the Casual Dots pattern, circular Tree Guards are mounted without any visible attachments using the Guardlock® system.





Design: Streetlife  
Protected by int. Model Depots and Patents

See also: Box Bins

Streetlife Brochure 2018 - 2019

## Tree Grilles CorTen Extra Fine

Six of the graphic patterns used in Streetlife's CorTen Tree Grids feature an extra-fine pattern of holes and slots. These comply with the US ADA guidelines. For use at ground level, we recommend the use of a CorTen ground level frame in order to ensure that the paving is properly supported and outlined.



Bubbles



Dots&Stripes

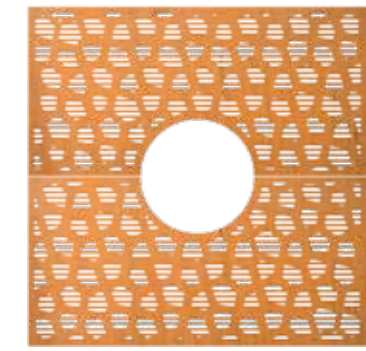

Magic&Stripes

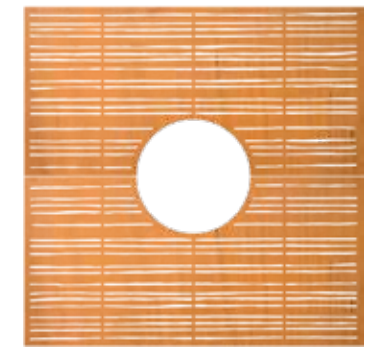

Bamboo

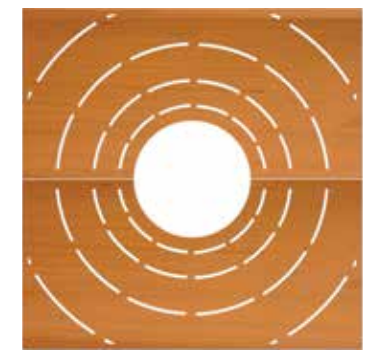

Ripple

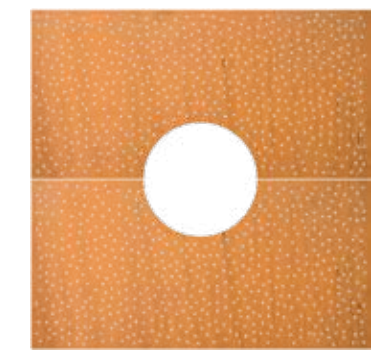

Kiwi

According to the US ADA guidelines for tree grids, the slots may be no wider than 12,5mm - 0.5". The Magic&Stripes pattern and various other Streetlife patterns comply with these guidelines.



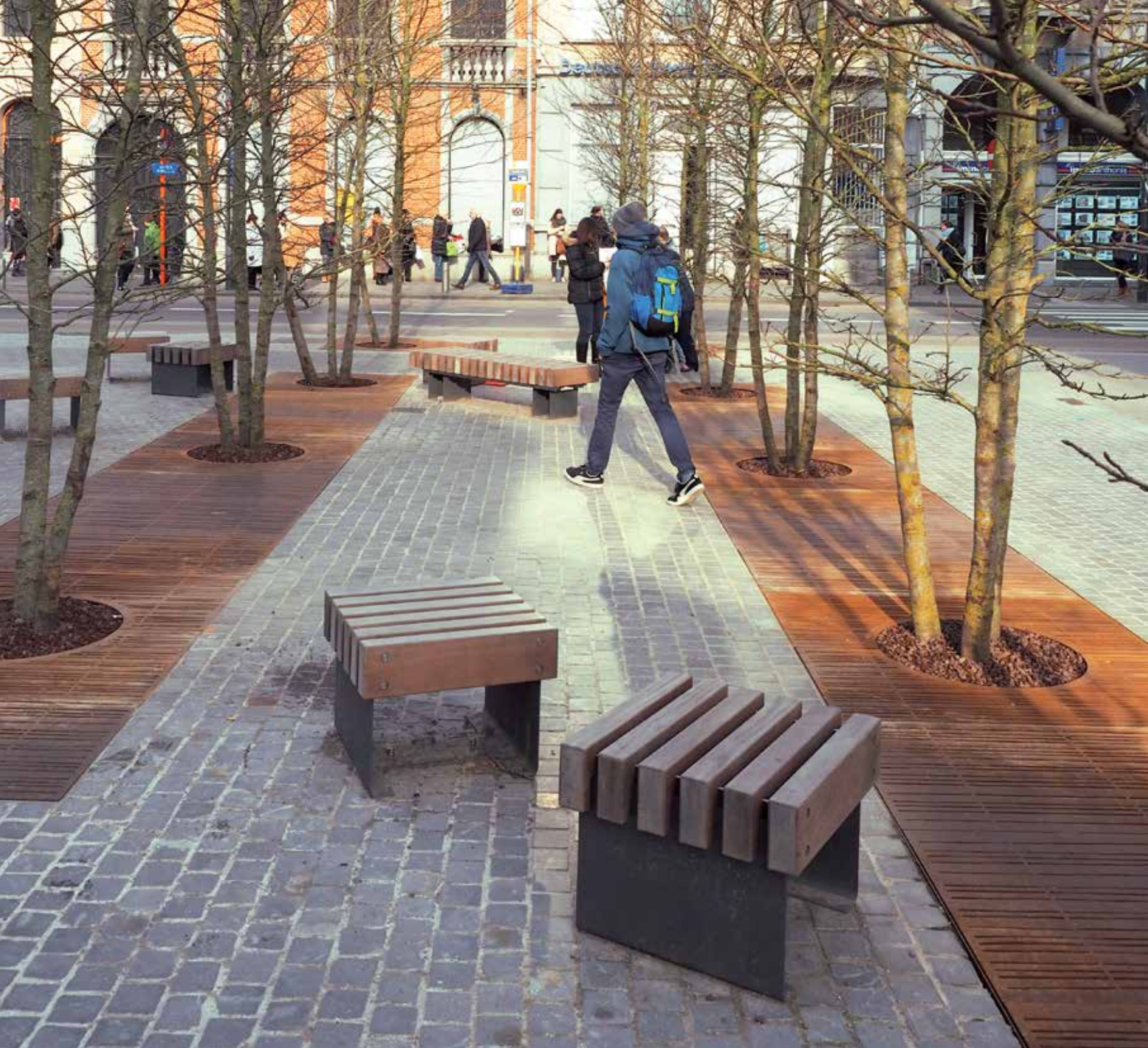

Design: Streetlife  
Protected by int. Model Depots and Patents

Box Bins  
Solid Grille Benches

Streetlife Brochure 2018 - 2019

## Tree Grilles Strips CorTen



Many tree experts ascribe social qualities to trees. For example, trees develop better if they can interact with other trees. Strip-shaped growing spaces with tree granules enable urban trees to develop to their full potential. Covering with CorTen Strip Grids is not only functional, but the strips also create a strong and beautiful image for the ground level design.

Streetlife will gladly advise you on modular and customised CorTen Strip Grids.





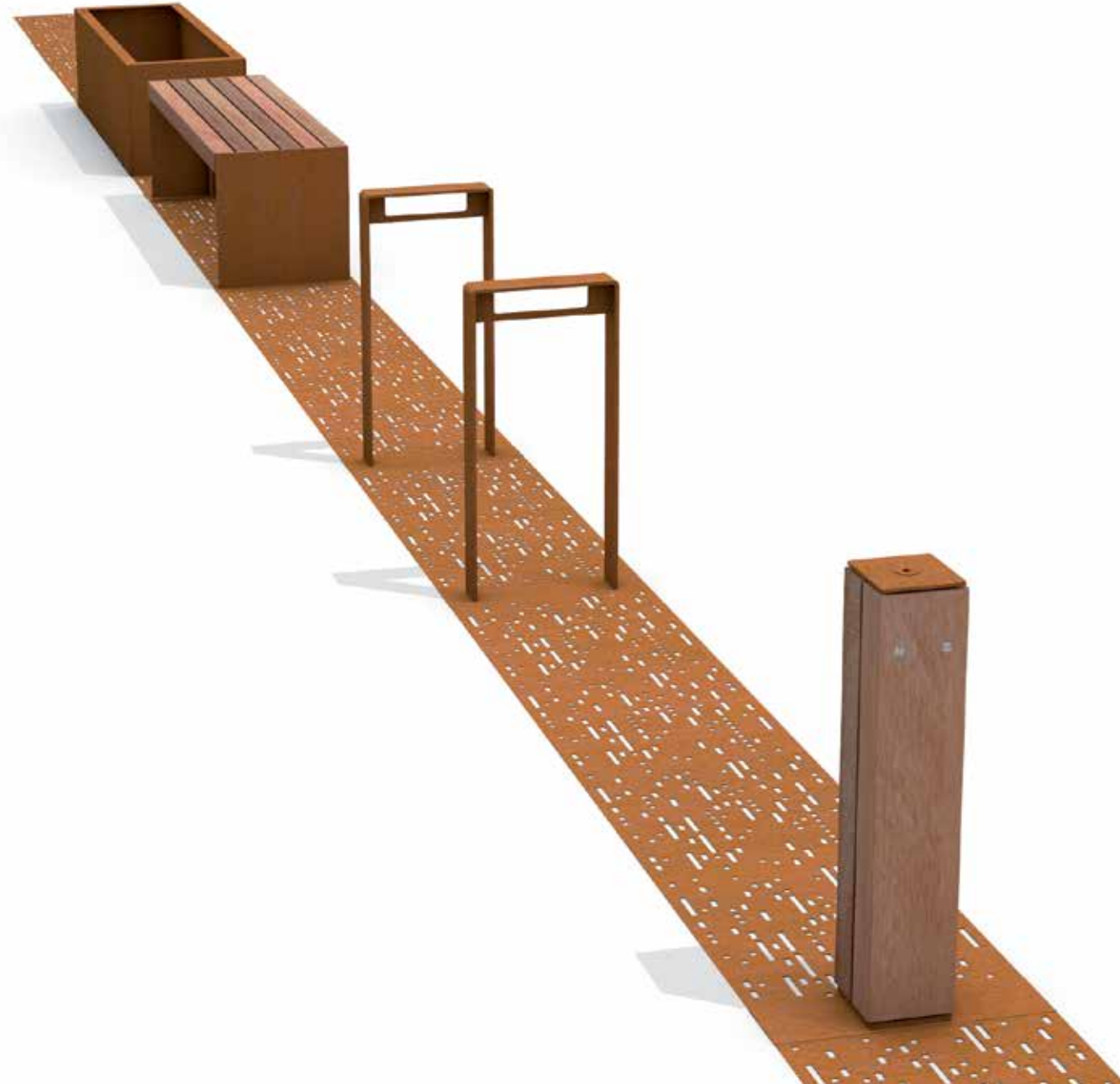

Design: Streetlife  
Protected by int. Model Depots and Patents

CorTen Bicycle Parking  
Solid Grille Benches

See also:

Streetlife Brochure 2018 - 2019

## Cortile System

NEW

Our climate is changing, with some regions experiencing extreme drought while others have to cope with large amounts of water. The **Cortile cover system** is designed for wide water drainage gutters with a high drainage capacity. The patterned CorTen sheets are installed in a 4cm-high mounting frame on the gutter. The Cortile is available in two different widths.

Module dimensions: 15x100cm (6x39") and 50x100cm (20x39")

The Cortile system combines well with simple CorTen street furniture such as CorTen Bicycle Racks or Grille Benches.

The combination of landscaping elements with a smart drainage and paving pattern creates a beautiful layout.

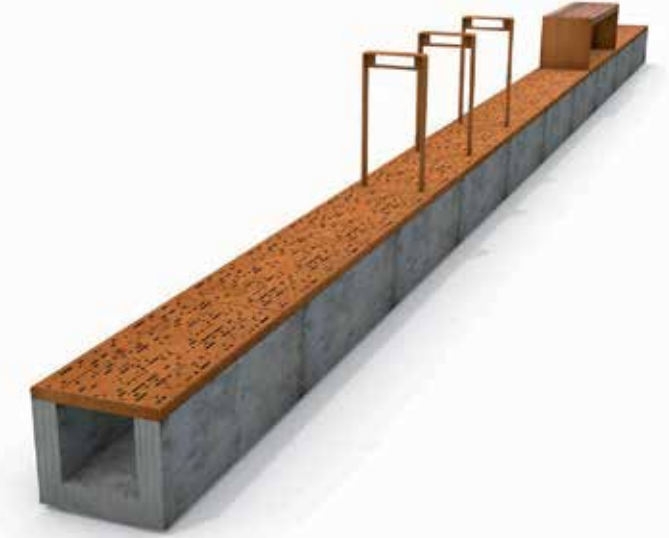



## Tree Guards CorTen

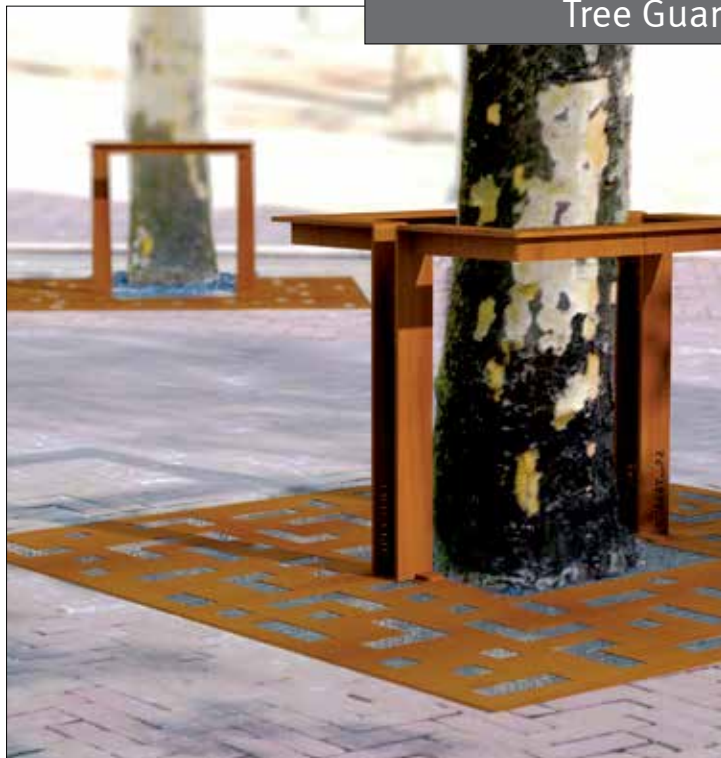

Finishing the Tree Guards in CorTen steel creates a beautiful coherence with the CorTen Tree Grids. The sustainable design of grid and guard delivers a warm, contemporary image that blends perfectly with trees. All Tree Guard models are fitted with the patented **Guardlock® mounting system**. This smart system ensures a beautifully detailed and solid mounting of guard to grid, without the fixings being visible. An additional reason to opt for quality by Streetlife.

The **Lotus Tree Guard** has continuous vertical CorTen slats. This sturdy tree guard has a more natural shape and is available in short (H=45cm - 18") and tall (H=120cm - 47") versions.



TGUA-LOT-D50-120-PC, Ø50, H= 120cm  
Ø20", H= 47"

TGUA-LOT-D70-45, Ø70, H= 45cm  
Ø28", H= 18"

TGUA-LOT-D60-120, Ø60, H= 120cm  
Ø24", H= 47"



Design: Streetlife  
Protected by int. Model Depots and Patents

Streetlife Brochure 2018 - 2019

## Tree Guards CorTen



TGUA-D58-60 Ø 58cm, H= 60cm | Ø 23", H= 24"  
TGUA-D58-100 Ø 58cm, H= 100cm | Ø 23", H= 39"  
TGUA-D58-135-PC Ø 58cm, H= 135cm | Ø 23", H= 53"

TGUA-D150-30 Ø 150cm, H= 30cm | Ø 59", H= 12"  
TGUA-D180-30 Ø 180cm, H= 30cm | Ø 71", H= 12"



TGUA-OTL-S59-70-CT 59x8x70cm | 23"X3"X27"  
TGUA-OTL-S69-80-CT 69x8x80cm | 27"X3"X31"

TGUA-CAR-S50-60 50x50x60cm | 20"X20"X24"  
TGUA-CAR-S60-60 60x60x60cm | 24"X24"X24"  
TGUA-CAR-S70-60 70x70x60cm | 28"X28"X24"

TGUA-SOL-S50-60 50x50x60cm | 20"X20"X24"  
TGUA-SOL-S60-60 60x60x60cm | 24"X24"X24"  
TGUA-SOL-S70-60 70x70x60cm | 28"X28"X24"

Design: Streetlife  
Protected by int. Model Depots and Patents

Streetlife Brochure 2018 - 2019

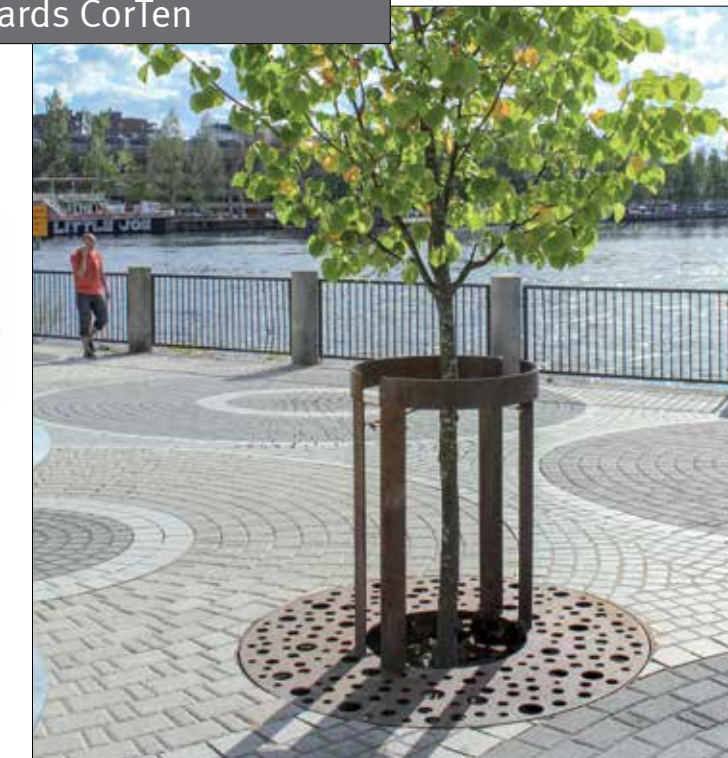

The **Round Tree Guard** is based on an understated, minimal design. The Tree Guard beautifully aligns with the roundness of the trunk and is available in 3 heights (H=60cm, 100cm & 135cm - 24", 39" & 53"). The Round Tree Guards are beautifully detailed and are a full-fledged alternative to the classic tree protector. The CorTen steel or stainless steel side plates join the two halves together.

The **Carré Tree Guard** is square-shaped and can only be combined with square tree grids. The combination with the matching Matrix pattern results in an angular design with Art Deco characteristics. The height measures 60cm - 24", and for large apertures a version with four supports is available.

The **Solid Tree Guard** combines a rugged design with an attractive wooden Solid top slat of FSC® hardwood. It is a sturdy guard that forms part of the Solid Series of street furniture.

The new **Tree Guard Outline** provides the optimal balance of transparency and support.



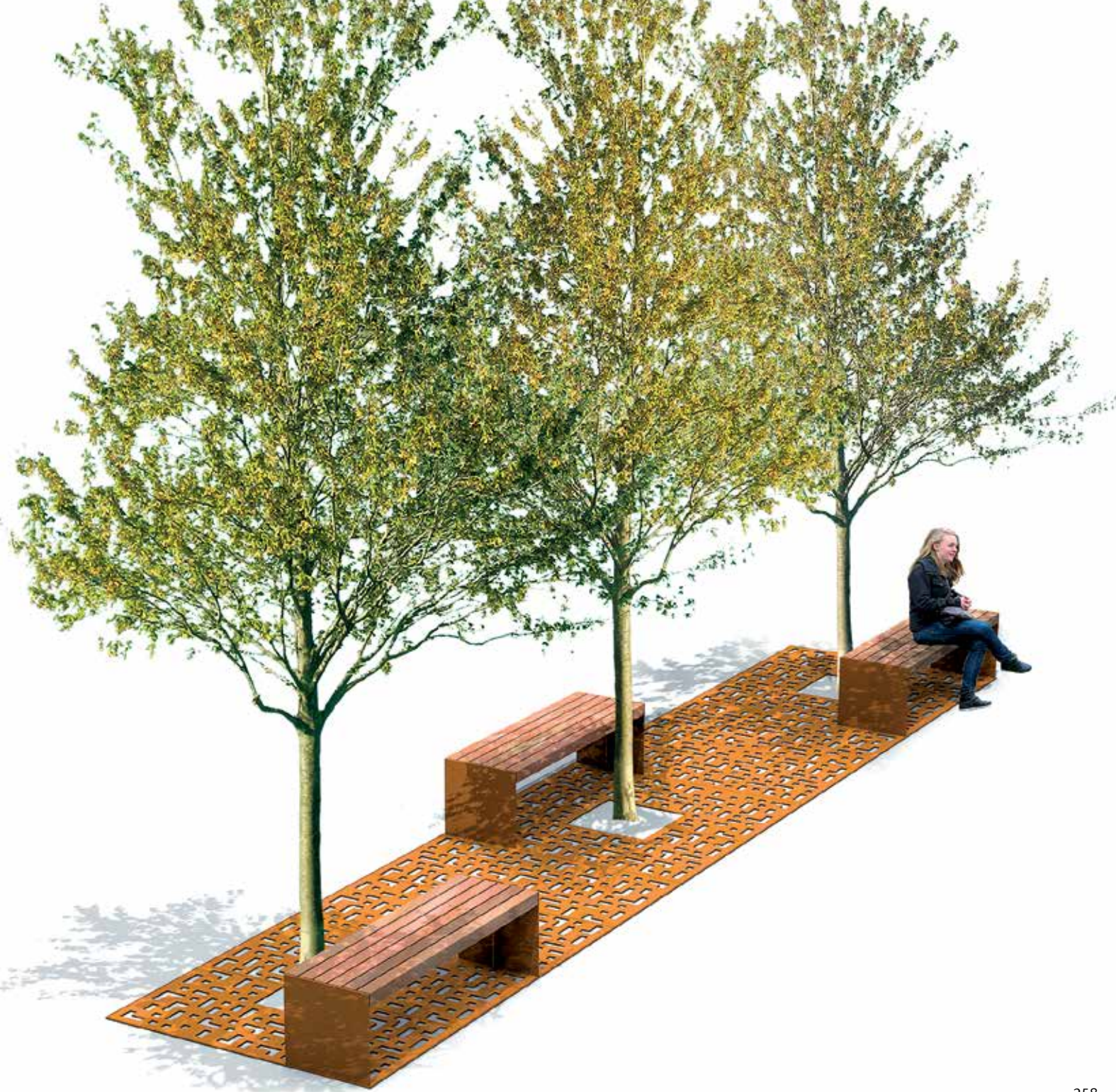

Design: Streetlife  
Protected by int. Model Depots and Patents

Solid 8 Benches  
Solid Green Benches  
Solid Podium Isles  
See also:

## Solid Grille Benches

People like to sit near trees. The **Solid Grille Bench** is a squared tree grille combined with a seat. Solid Grille Benches are available with both straight and diagonal ends for large tree grilles. The heavy gauge CorTen steel supports are fitted to the size of the tree grille.



**GRB-L6-120-CT + TGR-S120-CT**  
120x46x45cm  
47"X18"X19"

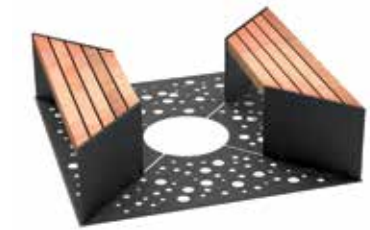
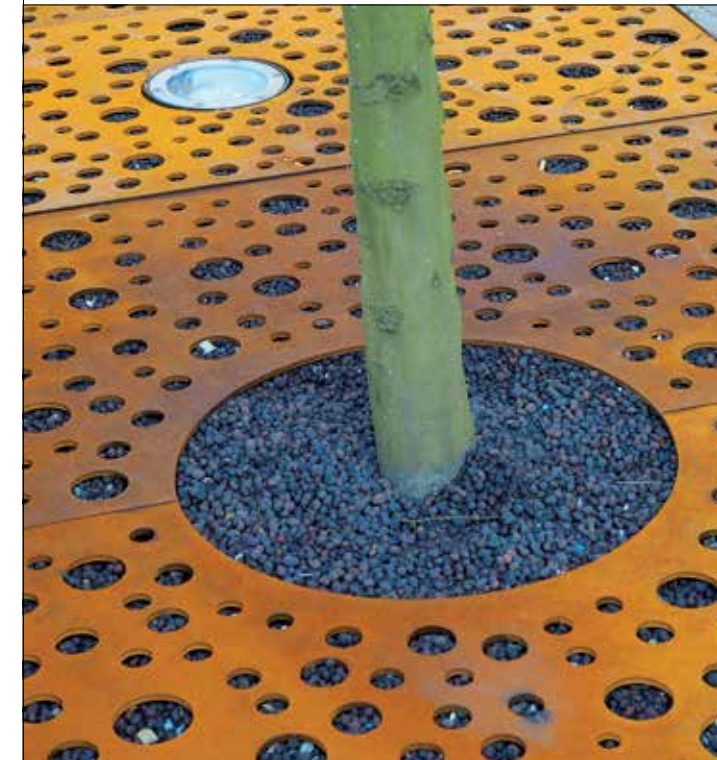

2 x **GRB-DIA-120-PC + TGR-S120-PC**, 120x40x47cm | 47"X16"X19"

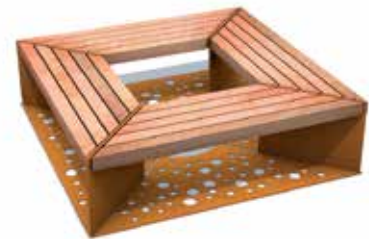

**GRB-DIA-O-150-CT + TGR-S150-CT**, 150x40x47cm | 59"X16"X19"  
**GRB-DIA-O-180-CT + TGR-S180-CT**, 180x40x47cm | 71"X16"X19"





Rough&Ready 6 Benches  
 Rough&Ready Tree Isles  
 Rough&Ready Basic Planters  
 Country Bridges

See also:

Design: Streetlife  
 Protected by int. Model Depots and Patents

## Rough&Ready Grille Benches

The large round Tree Grids with a diameter of 300cm are beautifully complemented by **Rough&Ready Grille Benches**, which are also fitted with CorTen supports. These are well-designed circular benches for use around large trees. Backrest elements and armrests can be mounted if desired.

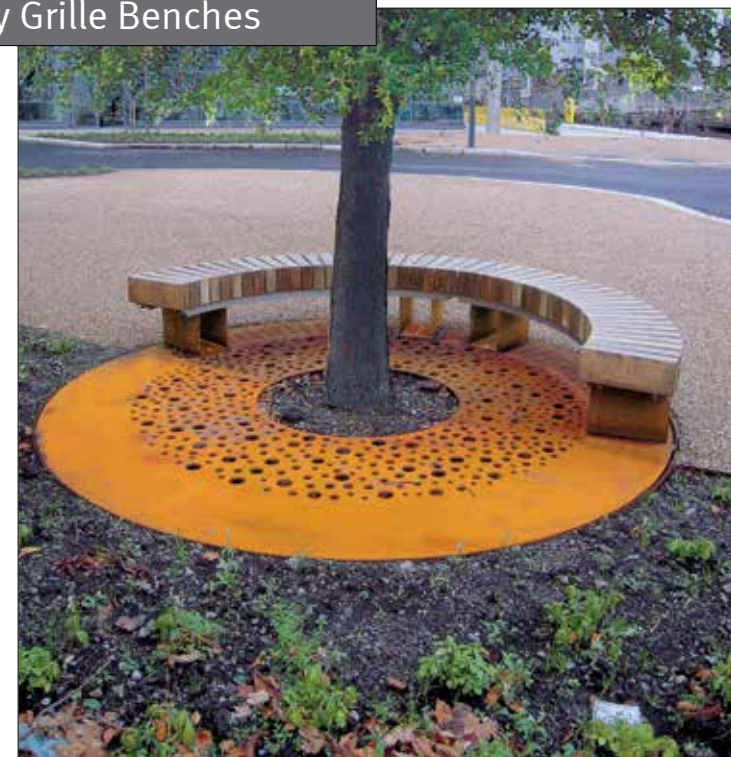



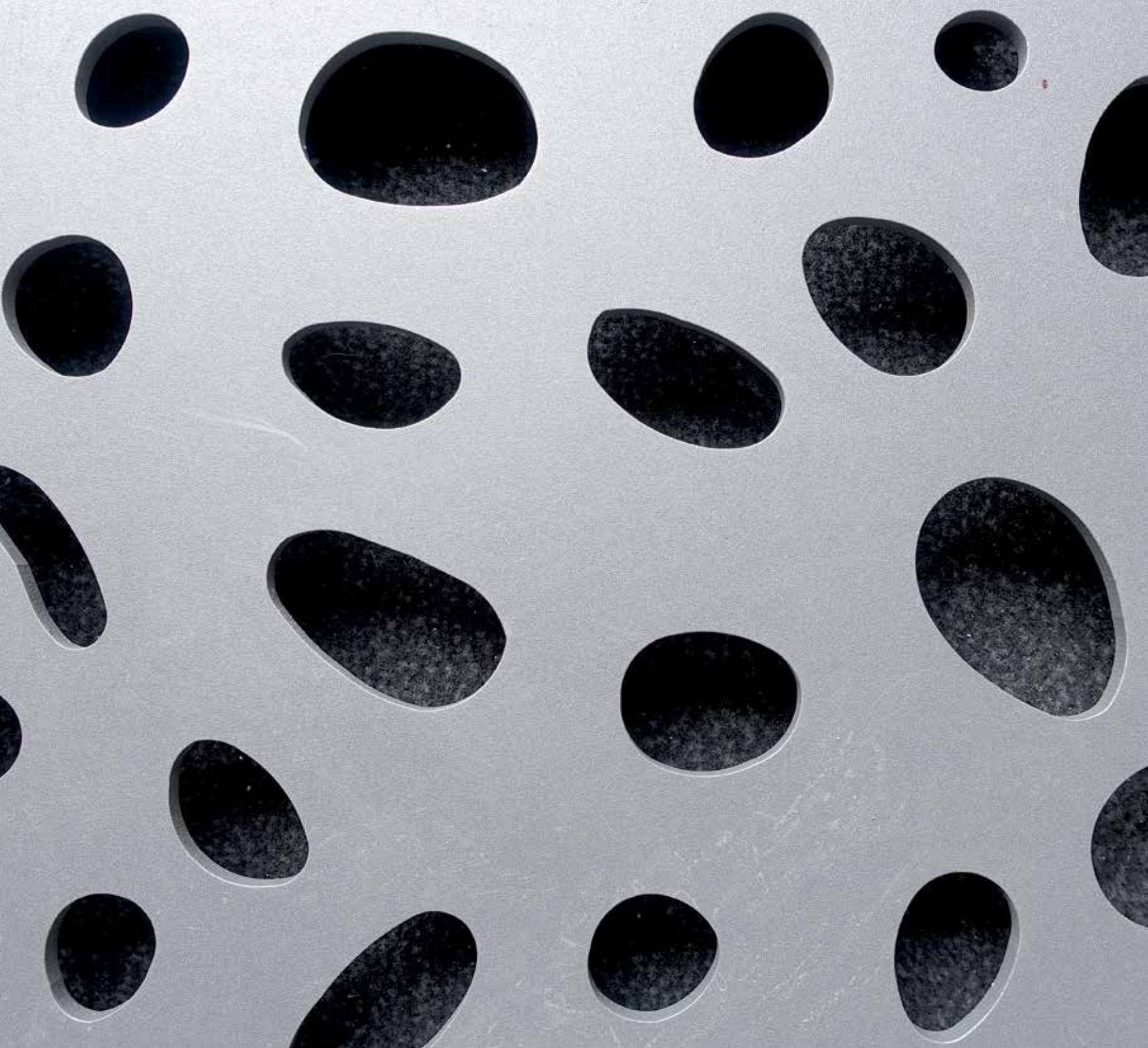

Design: Streetlife  
Protected by int. Model Depots and Patents

## Tree Grilles Black & Grey

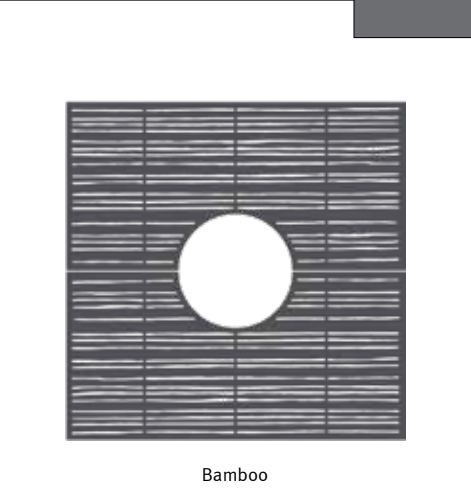

Bamboo

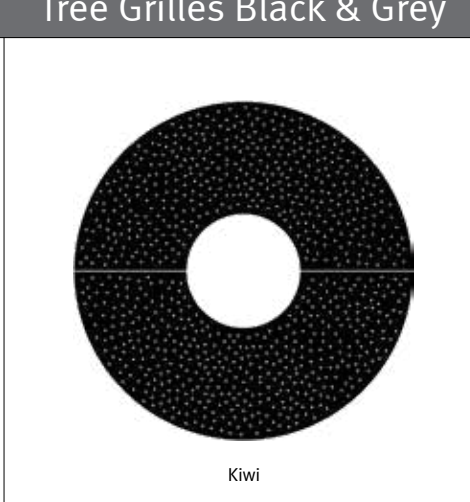

Kiwi

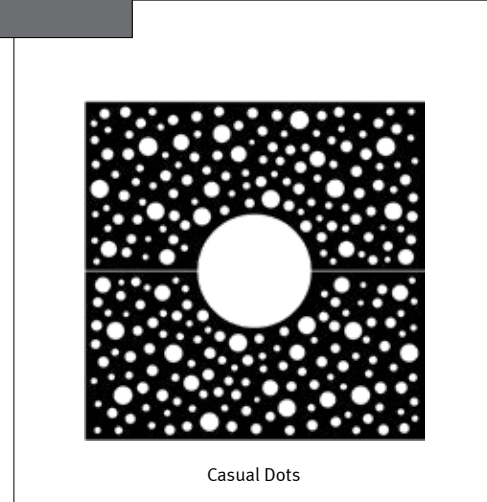

Casual Dots

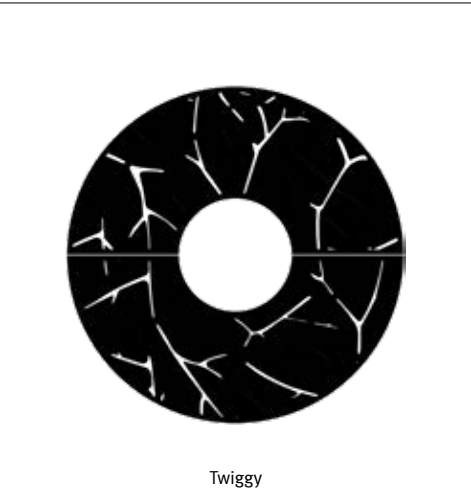

Twiggy

The CorTen Tree Grids can also be supplied with a **Colour** finish. This powder coating in grey (Streetlife DB Grau) or black (Streetlife Deep Black) has extra durable properties. Any deep scratches which may occur will turn dark and will not rust through under the coating.

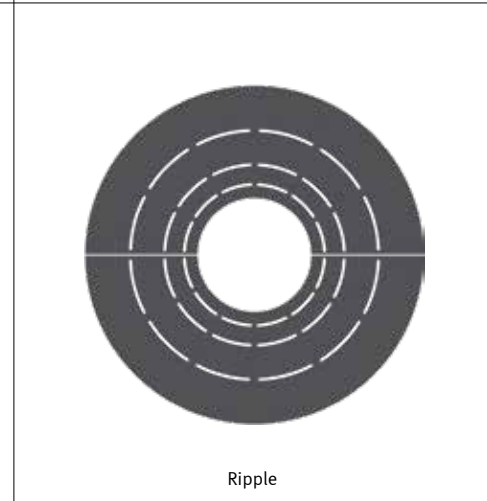

Ripple

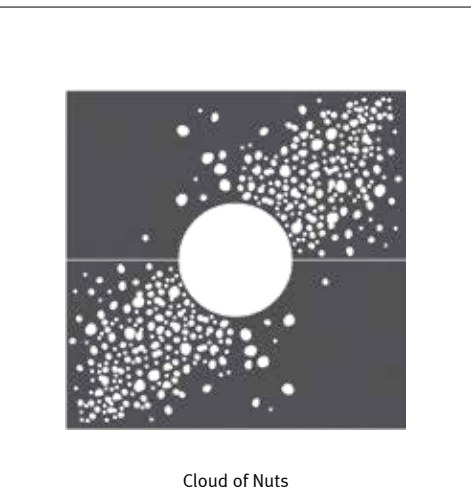

Cloud of Nuts

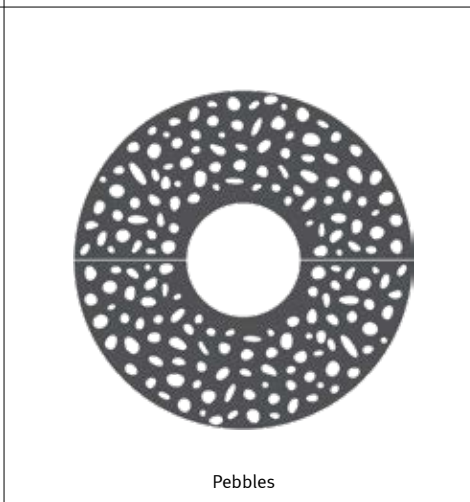

Pebbles

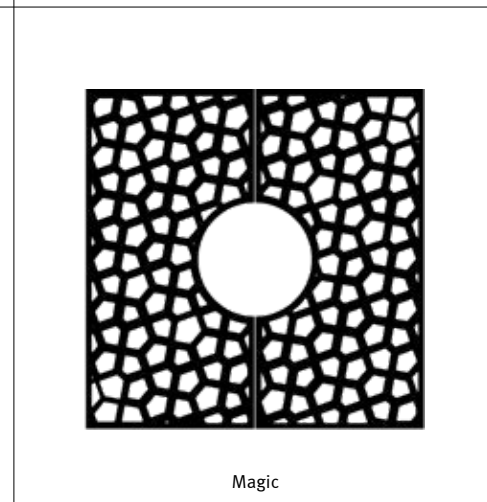

Magic



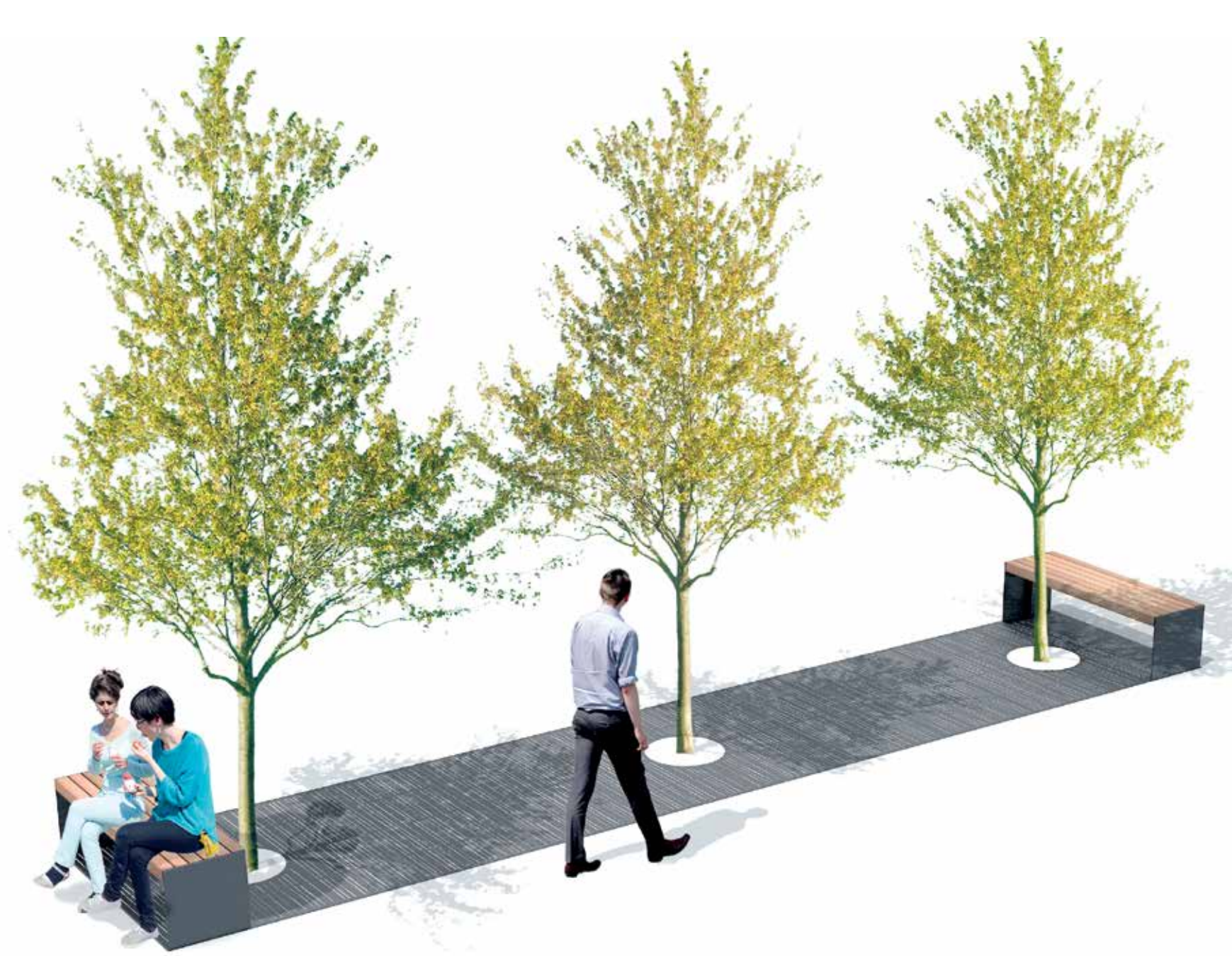

Design: Streetlife  
Protected by int. Model Depots and Patents

Tree Grilles Black & Grey

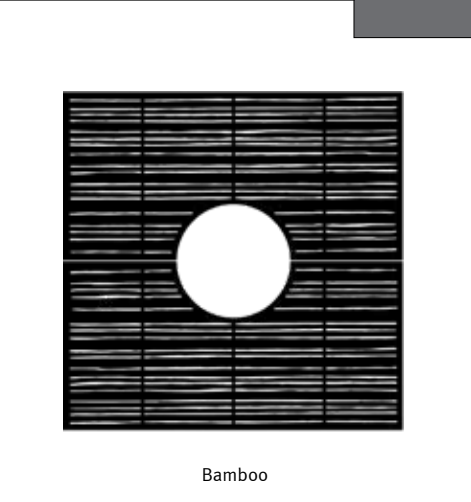

Bamboo

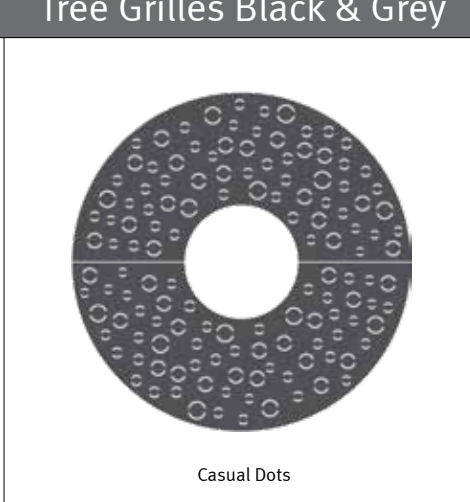

Casual Dots

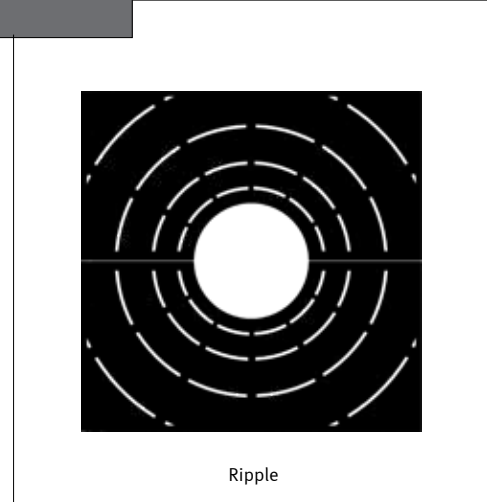

Ripple

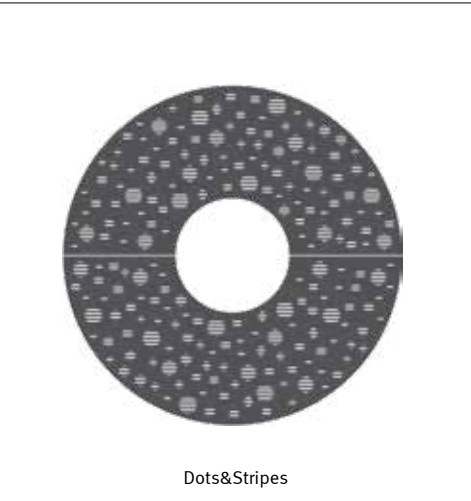

Dots&Stripes

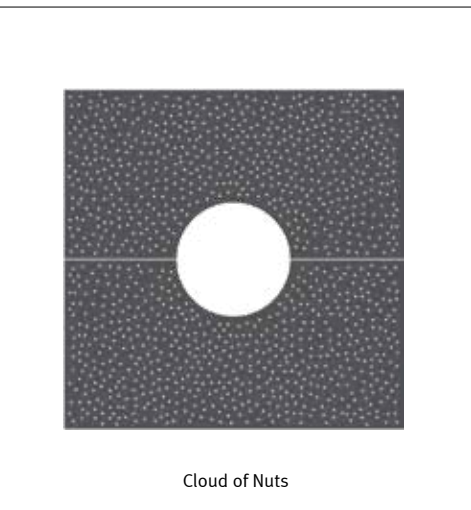

Cloud of Nuts



5

This straight Solid Grill Bench has been placed on an attractive square Tree Grid with Bamboo pattern. Both are coated in Streetlife's DB Grau extra durable finish.





Design: Streetlife  
Protected by int. Model Depots and Patents

## Tree Outlines



**TOL-D100-TH**  
Ø100cm | Ø39"



**TOL-S120-TH**  
120x120cm  
47"X47"



**TOL-D150**  
Ø150cm | Ø 59"



**TOL-S150**  
150x150cm  
59"X59"

The **Tree Outlines** are made of a round, thick-walled, rolled industrial bulb profile. On the top, the steel rim is equipped with a wide (25mm - 1") rim.

The Tree Outlines mark the growth location and form a neat yet solid edge to delineate and complete the street paving. These Outlines can be incorporated into street paving in one of several ways, e.g. flush or raised to hold back water containing gritting salt.

The surface level within the steel Tree Outline can be equipped with a finishing layer according to preference, such as resin-bound gravel. Bound gravel is porous and has proven to remain fully water- and oxygen-permeable.

It is possible to include groundspots in combination with the Tree Air® system. Various diameters can be produced on request. Available in unfinished carbon steel or thermogalvanized steel.

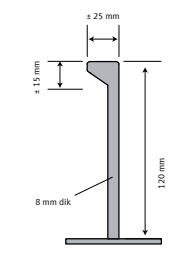

Raised rim: 6 - 7 cm high - 2"-3"



low rim: 2 cm high - 0.8"



Flush: no increase

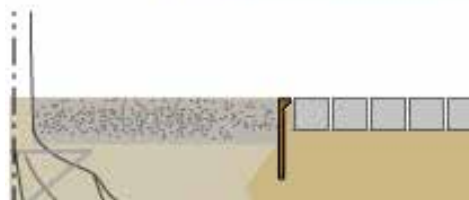





## Index



Box Bins Extra Slim **NEW**  
270



Box Bins  
272



Rough&Ready Bollards  
276



Bright Bollards  
278



Rough&Ready Bicycle Racks  
280



Rough&Ready Bike-Keys Stands  
283



Solid Bicycle Racks  
284



CorTen Bicycle Racks & E-bike  
286



Clip Bicycle Racks  
290

## Category 6 Bins, Bollards & Bicycle Parking

- Bins
- Bollards
- Bicycle Parking





Design: Streetlife  
Protected by int. Model Depots and Patents

See also: Tree Grilles Casual Dots

Streetlife Brochure 2018 - 2019

## Box Bins Extra Slim

**NEW**

This **Box Bin Extra Slim** is an extremely slim waste disposal container (40x40x97cm) with an attractive rain cover that can be ordered in stainless steel if desired. The front of the Box Bin Extra Slim features a Casual Dots pattern, meaning that the contents are clearly visible (anti-terrorism). The newly-developed mounting system for 120-litre plastic bags is very easy to access. Made of heavy gauge CorTen sheet steel with triangular lock. Also available in anthracite grey powder coating on request.

Min. order: 5 pcs / Bespoke Bins, min. order: 10 pcs



**BB-S40-CT + BB-S40-Lid-CI-ST**  
40x40x97cm  
16"x16"x38"



**BB-S40-PC + BB-S40-Lid-CI-ST**  
40x40x97cm  
16"x16"x38"

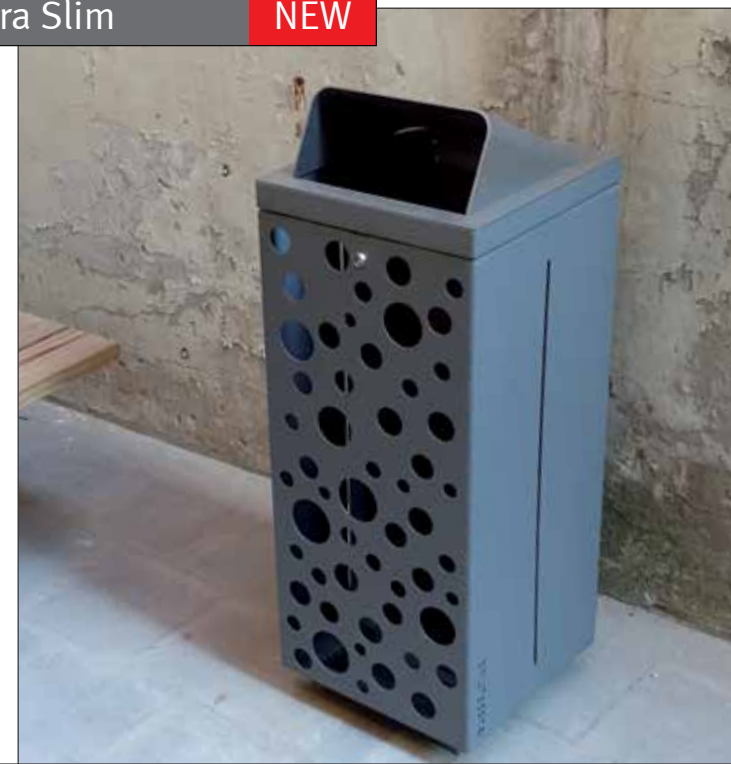

**BB-S40-PC + BB-S40-RCO-ST**  
40x40x97cm  
16"x16"x38"



**BB-S40-CT + BB-S40-RCO-CT**  
40x40x97cm  
16"x16"x38"



**BB-S40-PC + BB-S40RCO-PC**  
40x40x97cm  
16"x16"x38"



## Box Bins

The **Box Bins** are available in warm CorTen with a stainless steel cover. The thick-walled CorTen can be laser cut with our Casual Dots pattern. This makes for a recognisable design, and gives display to the contents i.e. an internal bag or wheelie bin. Applying the Casual Dots pattern to the Boxbins, which are also available in the Streetlife Tree Grilles, provides the designer with an option to create a more coherent overall scheme.

The stainless steel cover is available in two forms:

- With a single large opening (Ø: 320mm)
- With smaller openings, where rubbish can be easily separated

Width 49cm x 49cm - 19" x 19"  
Height 97cm - 38"



Design: Streetlife  
Protected by int. Model Depots and Patents

See also: Tree Grilles Casual Dots

Streetlife Brochure 2018 - 2019



**BB-S49-CT + BB-S49-Lid-CD-CT**  
49x49x97cm  
19"x19"x38"



**BB-S49-CD-CT + BB-S49-Lid-CI-CT**  
49x49x97cm  
19"x19"x38"



**2x BB-S49-CT + 2x BB-S49-Lid-CD-CT**  
98x49x97cm  
39"x19"x38"

## Box Bins



**BB-S49-PC + BB-S49-Lid-CD-ST**  
49x49x97cm  
19"x19"x38"

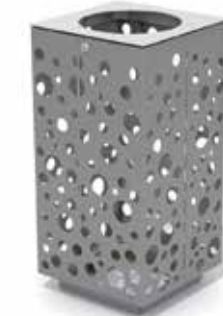

**BB-S49-CD-PC + BB-S49-Lid-CI-ST**  
49x49x97cm  
19"x19"x38"



**2x BB-S49-PC + 2x BB-S49-Lid-CD-ST**  
98x49x97cm  
39"x19"x38"

Design: Streetlife  
Protected by int. Model Depots and Patents

See also: Tree Grilles Casual Dots

Streetlife Brochure 2018 - 2019



Streetlife's **Box Bins** are waste disposal containers that reflect an understated design. These Box Bins give a modular Lego-block appearance when used in outdoor areas. Their rectangular design makes it easy to line up multiple bins harmoniously in order to create more capacity and/or waste sorting facilities. The sheet steel casing contains a bracket for fastening plastic garbage bags. The bin is emptied from the top. Because the hinged flap with waste openings is made of 316 stainless steel, cigarettes or other "sticky" waste cannot adhere to it. The flap is opened and closed using a triangular lock.

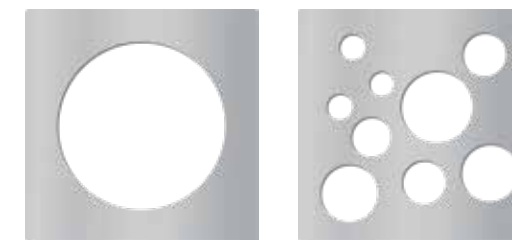



## Custom Bins

The picture shows the Bastiaansplein in Delft, with its 3 oval tree islands (9 x 4 m) with large pagoda trees on a car park. R&R benches and R&R bicycle stands were also installed on the square. Public appreciation of the urban square has risen enormously since the 3 oval Isles have been installed there: above 85%. The Isles also accommodate large, sunken Wastepaper Bins.

Waste container volume	plastic bag approx. 120 Litre
Minimum order wastepaper bins	6 items
Delivery time	10-12 weeks



Design: Streetlife  
Protected by int. Model Deposits and Patents

See also: Rough&Ready Tree Isle

Streetlife Brochure 2018 - 2019

Due to the large power of attraction of the Streetlife Tree Isles, as well as their ability to be neatly integrated in the construction, it is advisable to incorporate Streetlife wastepaper bins in the Isles. These CorTen steel bins, with a 316 stainless-steel flap are partly sunken into the Isle. Accordingly, the ground level remains free of detached street furniture. The bin protrudes 45 cm above the Isle, so that the deposit height is 90 cm. The stainless-steel flap is opened by means of a triangular key.

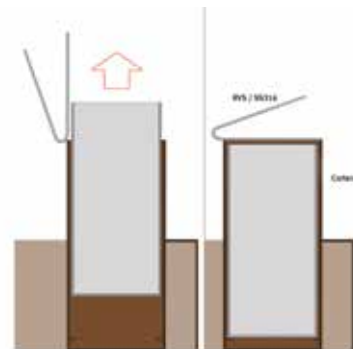

## Custom Bins

In 2014, the prestigious Triangeln Shopping Centre in Malmö was completely renovated. Streetlife delivered multiple furniture configurations for the landscaping of the public spaces. In close collaboration with the Swedish architect and engineer office Sydark Konstruera, integral linear configurations were designed: long benches with crosswise positioned slats combined with sustainable greenery, **newspaper displays and waste paper bins**. The architect produced the first sketches, after which Streetlife took care of the technical and aesthetic detailing. Architecture and custom-made landscaping elements were perfectly coordinated.

Would you like to install rubbish bins and the like that blend harmoniously with the area's identity? Streetlife will be happy to make a design plan.



Design: Streetlife  
Protected by int. Model Deposits and Patents

Streetlife Brochure 2018 - 2019



Newspaper displays



Waste paper bins





These R&R Bollards in London's Canary Wharf are accompanied by custom-made CorTen Bollards that were developed in consultation with the client.

Design: Peter Krouwel  
Protected by int. Model Depots and Patents

Rough&Ready 6 Benches  
Rough&Ready Tree Isles  
Rough&Ready Basic Planters  
Country Bridges

See also:

Streetlife Brochure 2018 - 2019

## Rough&Ready Bollards

The R&R range also includes the robust **Rough&Ready Bollards**:  
These robust beams in FSC® hardwood or in All Black are combined with a solid galvanized steel or CorTen steel frame.  
The beams are covered on the top and are mounted by means of stainless-steel theft-proof flange nuts.

Height 75cm - 30"  
Cross-section 15x15cm - 6"x6"







Design: Streetlife  
Protected by int. Model Depots and Patents

## Bright Bollards

Robust **Bright Bollards** are made of thick-walled CorTen steel with an integrated stainless steel sheet to spread the LED light. The bollards are LED-Ready, which means that a standard LED fixture can be mounted at the top of the bollard by a local electrician, or optionally included by Streetlife. The CorTen Bollard can be securely and invisibly anchored to the surface, or with a steel ground anchor invisibly.

Heights            90cm and 38cm - 35" and 15"  
Groundwork       15x15cm - 6"x6"



**BR-BOL-38**  
15x15x38  
6"x6"x15"

**BR-BOL-90**  
15x15x90  
6"x6"x35"





Design: Peter Krouwel  
Protected by int. Model Depots and Patents

Rough&Ready 6 Benches  
Rough&Ready Big Green Benches  
Rough&Ready Tree Isles  
Rough&Ready Basic Planters

See also:

Streetlife Brochure 2018 - 2019

## Rough&Ready Bicycle Racks

**Rough&Ready Bicycle Rack** is an attractive supporting stand for bikes. The hole in the steel support is for fixing the bike to the stand with a chain lock. The Rough&Ready 7x15cm - 3"x6" beam divides the space in a minimalistic way horizontally between bikes. The untreated and sustainable FSC® hardwood bar also ensures that there will be no damages to the bicycle. For the first time, streets can be furnished with a natural, user-friendly yet robust bicycle stand. Streetlife advises placing the R&R stands at spatial intervals of 95cm - 37". The steel support is available in galvanized and CorTen steel or (optionally) in a powder coated RAL colour. It can be supplied with a concrete base.



**R&R-BP-CT**  
70x7x75cm  
28"x3x30"



**R&R-BP-TH**  
70x7x75cm  
28"x3x30"



**R&R-BP-PC**  
70x7x75cm  
28"x3x30"

The Rough&Ready Bicycle Rack has a unique appearance. A user-friendly supporting stand, it is fitted with a hole for fixing the bike to the stand with a chain lock.



## Rough&Ready Inline Bicycle Parking

The **Rough&Ready Inline Bicycle Parking** has a robust, natural appearance. The stands themselves are made of CorTen or galvanised steel and can be optionally finished in an RAL colour. The supporting bar consists of a sturdy FSC® hardwood R&R beam, which will not damage the bicycle frame. The long Inline configuration comprises a traditional bicycle parking facility, but in a new and modern format, and offers many parking spaces on a small surface area. The height of the fence is 75cm - 30". The system can be extended endlessly.

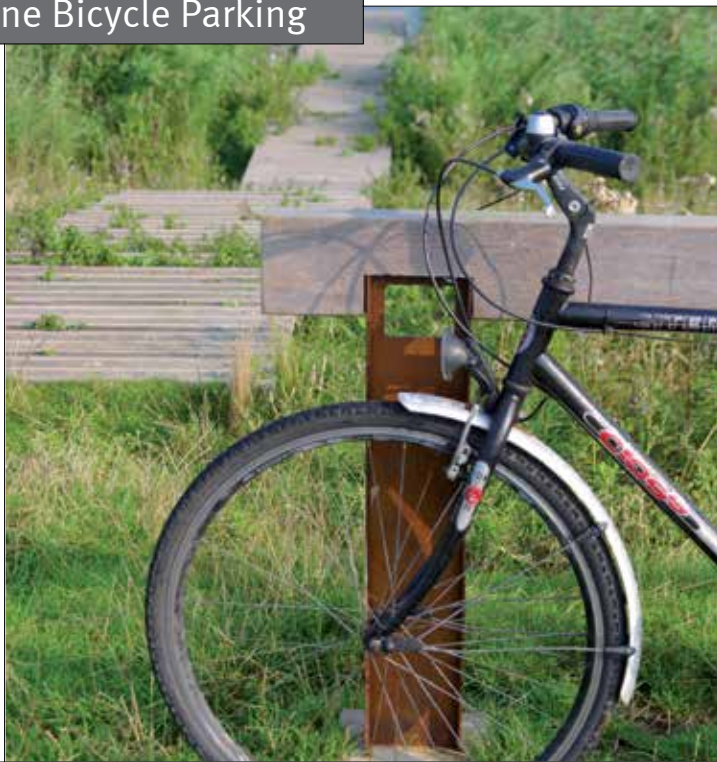

Design: Peter Krouwel  
Protected by int. Model Depots and Patents

See also:  
Rough&Ready 6 Benches  
Rough&Ready Big Green Benches  
Rough&Ready Tree Isles  
Rough&Ready Basic Planters

Streetlife Brochure 2018 - 2019



2x **R&R-BP-Post-TH + R&R-Beam-234**  
234x7x75cm  
92"x30"



3 x **R&R-BP-Post-TH + 2 x R&R-Beam-234-AB**  
468x7x75cm  
92"x30"

Rough&Ready 6 Benches  
Rough&Ready Big Green Benches  
Rough&Ready Tree Isles  
Rough&Ready Basic Planters

See also:

Streetlife Brochure 2018 - 2019



## Rough&Ready Bike-Key Stand

The **Bike-Key Bicycle Rack** is a bicycle stand with a contemporary design. The R&R hardwood beam of 7x15cm - 3x6 is anchored to the surface with poured concrete or by means of a separately available steel ground anchor.

A strip made of thick-walled CorTen steel, hot-dip galvanised steel or stainless steel 316 completely covers the ends of the hardwood beam. Due to the beautifully curved strip, the bicycle can be conveniently fixed to the stand with a chain lock. The strip is mounted by means of stainless-steel anti-theft flange nuts.



**R&R-BP-ST**  
70x8x70cm  
28" x 3" x 28"

**R&R-BP-TH**  
70x8x70cm  
28" x 3" x 28"

**R&R-BP-CT**  
70x8x70cm  
28" x 3" x 28"





Design: Streetlife  
Protected by int. Model Depots and Patents

Solid 8 Benches  
Solid Green Benches  
Solid Podium Isles

Streetlife Brochure 2018 - 2019

## Solid Bicycle Racks

**Solid Bicycle Racks** are basic lean-support racks fitted with a sturdy wooden top beam measuring 7x7cm - 28"x28". They are part of Streetlife's Solid product range. The untreated and sustainable FSC® hardwood prevents damage to the bicycle and creates an inviting image. Streetlife recommends placing the racks 95cm - 37" apart. Mounting methods include surface mounting (in concrete slab if necessary) and in-ground mounting into concrete. The racks have an above-ground height of 75cm - 30". A slot-shaped opening in the steel strip under the wooden beam allows for bicycles to be secured with a cable or chain lock. The steel strip is available in galvanized or powder-coated options.

Width 70cm - 28"  
Height 75cm - 30"



**SOL-BP-70-CT**  
75x7x70cm  
29"x28"

**SOL-BP-70-TH**  
75x7x70cm  
29"x28"

**SOL-BP-70-PC**  
75x7x70cm  
29"x28"

Solid Bicycle Racks are distinctive lean-support racks that are part of Streetlife's Solid product range. The FSC®-hardwood top bar prevents damage to the bicycle and relates back to other parts of our Collection.





## CorTen Bicycle Racks

The **CorTen Bicycle Racks** have a minimalist design combined with warm, thick-walled CorTen steel.

Fitting CorTen Bicycle Racks with a standard plastic All Black anti-damage strip prevents damage to bicycle frames. The top side incorporates a slot for bike chains and locks. They can be mounted individually or linked underground, which is highly suitable for creating long, straight rows.

Width 70cm - 28"  
Height 75cm - 30"

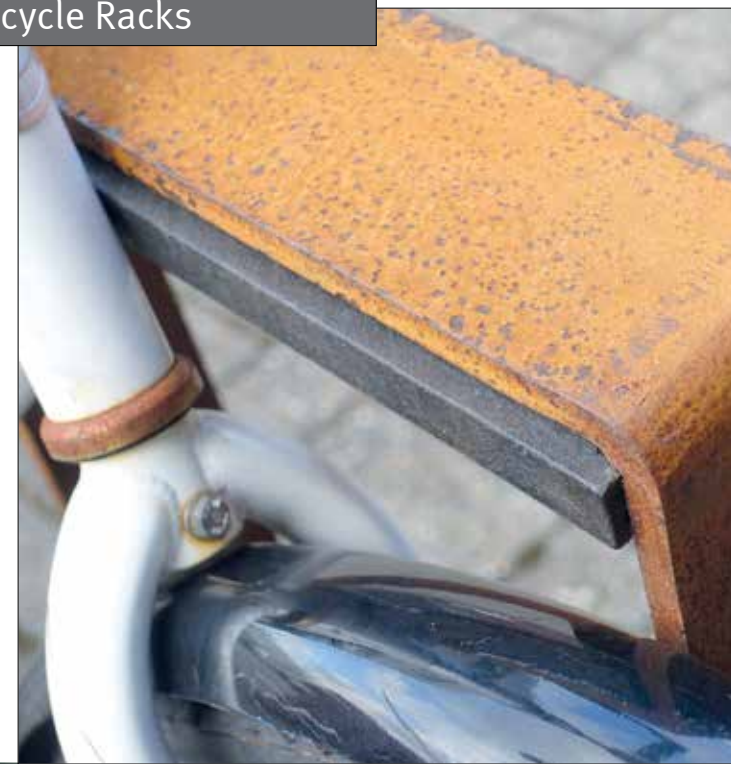

**BP-70-CT**  
75x7x70cm  
29"x28"

Design: Peter Krouwel  
Protected by int. Model Depots and Patents

Streetlife Brochure 2018 - 2019





## E-Bike Bicycle Rack

E-Bikes, or electric bikes, are becoming increasingly more popular. They are proving to not only be in demand among senior cyclists, but are also clearly replacing scooters in Western Europe. In the Netherlands, E-bikes account for more than 58% of all bicycle sales. The CorTen **E-Bike Bicycle Rack** meets the growing need for public spaces to provide more electric charging stations for bicycles.

The bike rack is fitted with a grounded electrical outlet and cover (220 volts or 110 volts) on both sides. The E-Bike Racks look great when combined with Streetlife's standard CorTen bicycle racks. CorTen E-Bike Racks are standard-equipped with a plastic AB anti-damage strip that prevents damage to bicycle frames.

Width 35cm - 14"  
Height 75cm - 30"

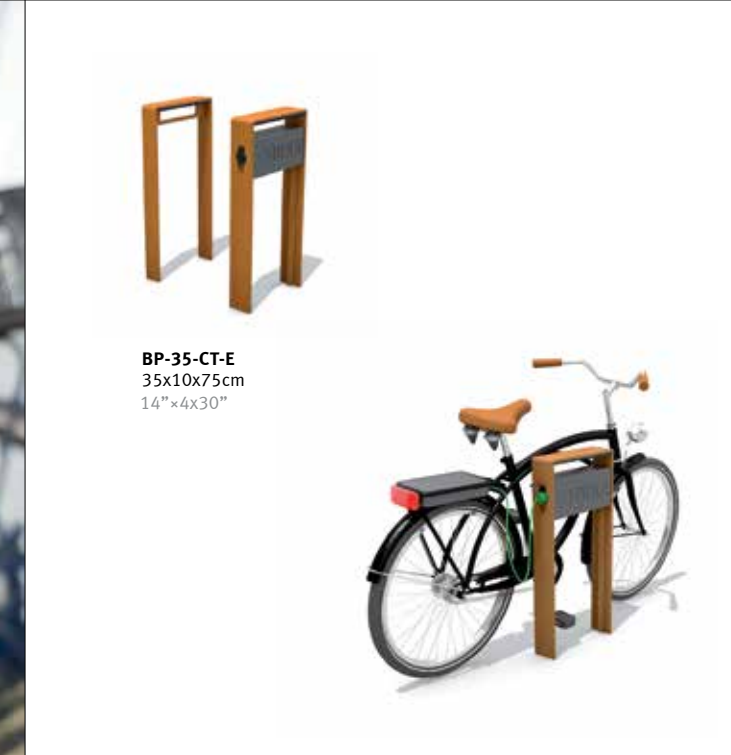

Design: Streetlife  
Protected by int. Model Depots and Patents

Streetlife Brochure 2018 - 2019





Many of the Clip Bicycle Racks can be seen in the historic centre of Leiden (NL). Their simple, honest design blends perfectly with both historical buildings and contemporary architecture.

Design: npk design  
Protected by int. Model Depots and Patents

Streetlife Brochure 2018 - 2019

## Clip Bicycle Racks

The **Clip Bicycle Rack**, being as simple and inconspicuous in the streets as a paperclip on a desk, can be applied anywhere: from monumental areas to modern architectural surroundings. This timeless design supports all types of bikes which can easily be chain-locked to the racks for additional security. The Clip bicycle racks has been awarded the Dutch quality mark for reliable cycling facilities: FietsParKeur 2002.

The Clip is available in galvanized and stainless steel or optionally powder coated. However, damage to the coating owing to rough handling is unavoidable. The racks can be interlinked with an underground connection, which makes them exceptionally suitable to create long, straight lines of bicycle racks. However, they are also available as individual racks on a concrete base.

Pipe  $\varnothing$  4.2cm - 2"







Index



Rough&Ready Curved Shades  
292



Rough&Ready Linear Shades  
294



Rough&Ready Shades with Wooden Column **NEW**  
298



Ivy Towers  
300



Parklet System **NEW**  
310



Valley Shelters  
304



Open Pillars  
306

Category 7  
**Shades, Pillars & Parklets**

- Shades
- Parklets
- Pillars





The Rough&Ready Shade System enables the creation of all sorts of cool leisure spots: comfortable places to take a break, a contemporary pergola, a public transport waiting area, etc.

Design: Streetlife  
Protected by int. Model Depots and Patents

Rough&Ready 5 Benches  
Rough&Ready Crosswise Top Seats

Streetlife Brochure 2018 - 2019

## Rough&Ready Shades Linear

Part of Streetlife's Rough&Ready product range, Rough&Ready Shades offer a modular shade solution for public spaces. The **Rough&Ready Shades Linear** can be used to create straight and angular shade structures. The system's standard modular dimension is 240/300x300cm (94"/118"x118"). The R&R wooden beams measure 7x15cm - 2.8x5.9". The roof modules can be assembled with the beams running lengthwise or crosswise. The beams are fitted onto heavy gauge Streetlock® combs that are fully integrated with the structure, satisfying both function and providing an attractive form. The beams are only available in light and durable W-Wood®.

The W-Wood® used is European FSC® pine made extremely durable through a process of deep treatment with a natural wax compound. The W-Wood® used has a similar life expectancy to FSC® hardwood, but has a lower density and hardness. The polychrome honey brown will fade very gradually to a greyer tone (over a period of about 3 years).

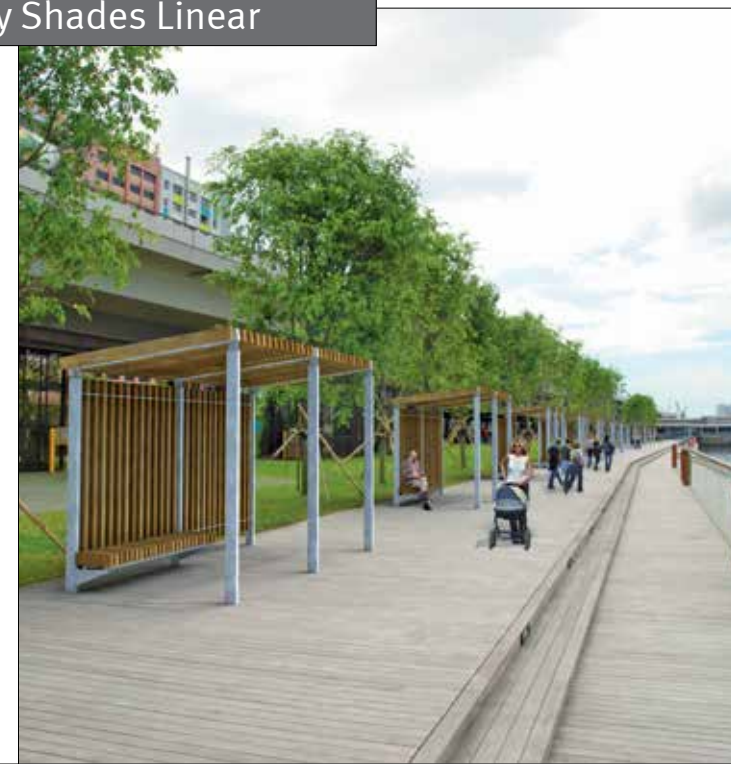

drip-proof roofing



lengthwise modules



crosswise modules







The Curved Shade System merges beautifully into the landscaping design. A contemporary pergola with architectural detailing.

Design: Streetlife  
Protected by int. Model Depots and Patents

Rough&Ready Curve Benches  
Rough&Ready Crosswise Top Seats  
See also:

Streetlife Brochure 2018 - 2019

## Rough&Ready Shades Curved

Part of Streetlife's Rough&Ready product range, **Rough&Ready Shades Curved** offer a modular shade solution for public spaces. The R&R wooden beams measure 7x15cm - 2.8"x5.9". The beams are fitted onto heavy gauge Streetlock® combs that are fully integrated with the structure, satisfying both function and providing an attractive form. The beams are only available in light and durable W-Wood® in honey brown colour. The W-Wood® used is European FSC® pine made extremely durable through a process of deep treatment with a natural wax compound. The W-Wood® used has a similar life expectancy to FSC® hardwood, but has a lower density and hardness. The polychrome honey brown will fade very gradually to a greyer tone (over a period of about 3 years).

The steel structure can be galvanized or finished with an RAL- coating. This modular system allows for a variety of layout configurations, including circular shaped-structures with a minimum radius of 10 metre as well as straight and angular arrangements.

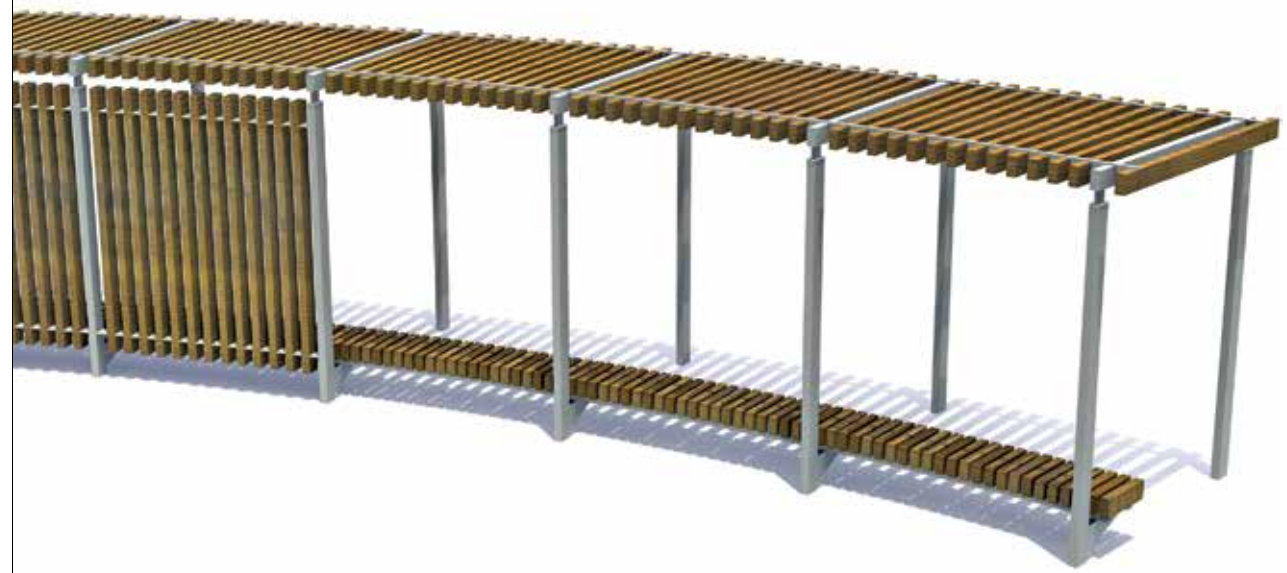
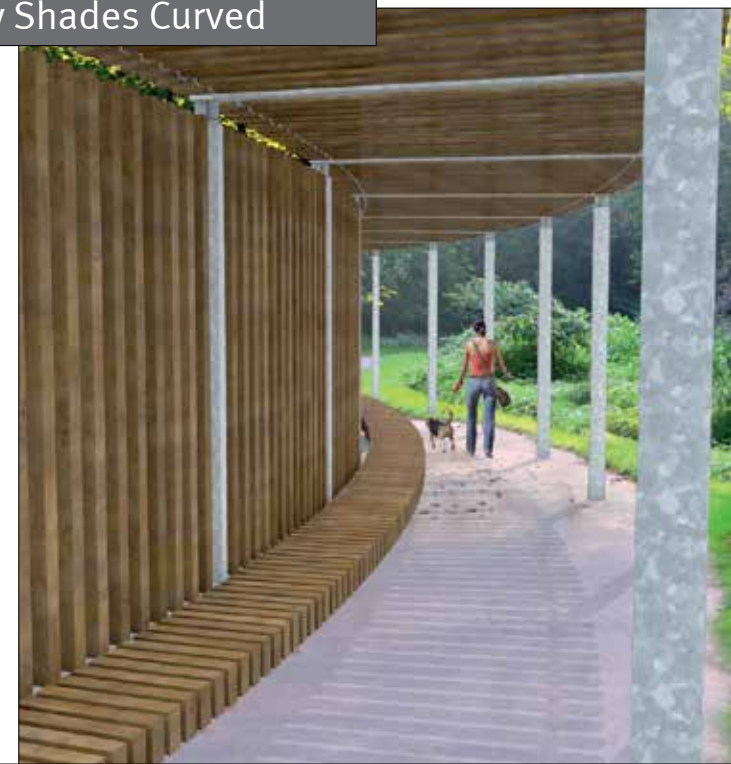

The inspiring Curved Shade System offers a range of possibilities. Ask our architectural advisors about the options.





R&R Shades Wooden Columns

NEW

The Rough&Ready Shade system is part of the extensive Rough&Ready range, which uses one modular wood size measuring 7x15cm - 2.8"x5.9". The double wooden columns with galvanised steel construction elements are a new addition: the **Rough&Ready Shades Wooden Columns**. To reduce the weight, the Shade is executed in W-Wood.

The extensive pergola system takes on an even warmer character when combined with LED lighting.

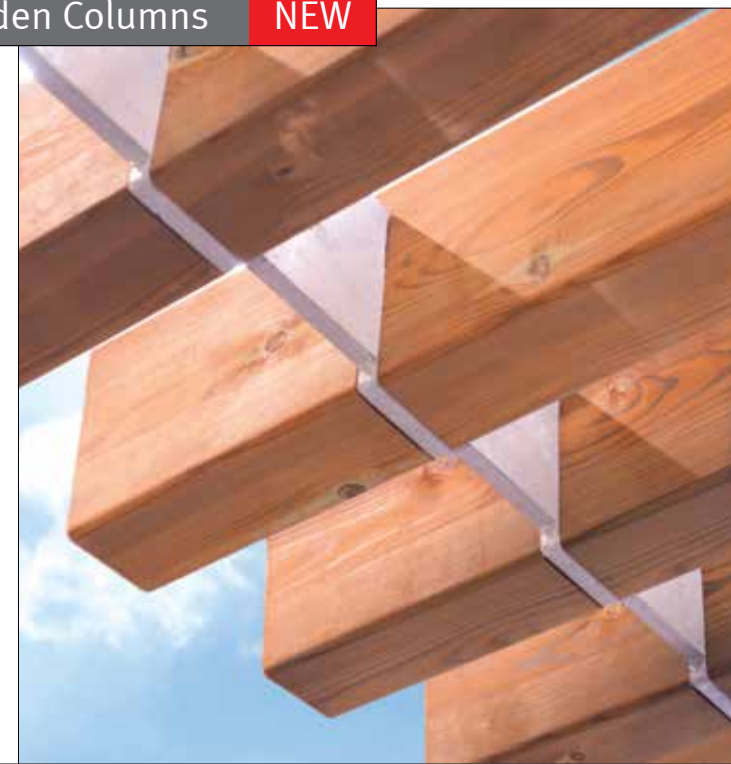

Design: Streetlife  
Protected by int. Model Depots and Patents

Rough&Ready 5 Benches  
Rough&Ready Crosswise Top Seats

See also:

Streetlife Brochure 2018 - 2019







Design: Streetlife  
Protected by int. Model Depots and Patents

## Ivy Towers

The **Ivy Towers** are green pillars for urban areas. The cylindrical base is constructed of CorTen steel, 220cm diameter. If desired it can be fitted with a semi-circular seat of Solid slats (7x7cm-2.8"x2.8") made of FSC® hardwood.

The Ivy Towers are a standard 500cm tall and are fitted with wire mesh for climbing plants. They are available in warm CorTen or coated in RAL colour. Consult your plant specialist to find the perfect climbing plant for your needs!

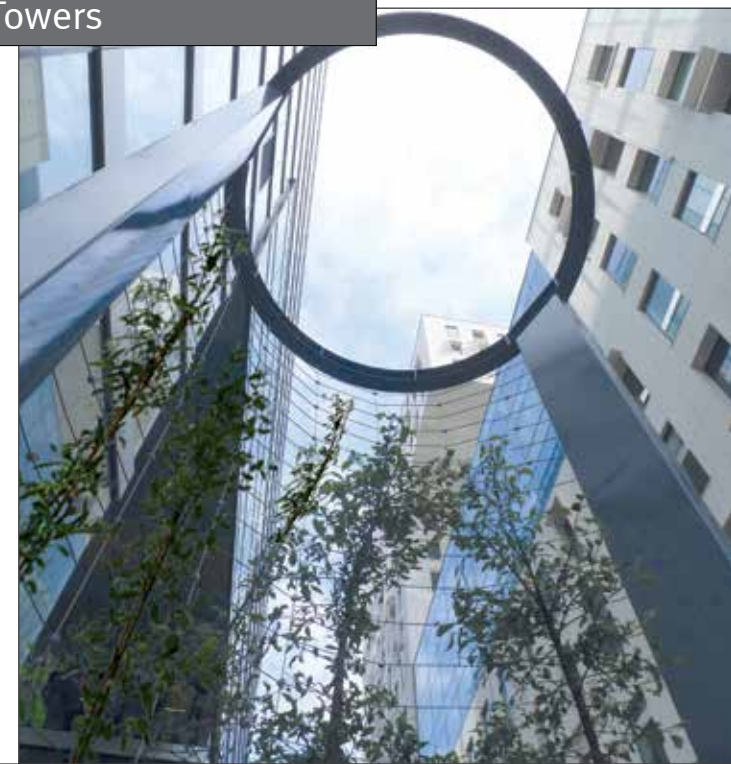

Streetlife Brochure 2018 - 2019







Design: Streetlife  
Protected by int. Model Depots and Patents

## Ivy Towers

A wide range of climbing plants can grow on the **Ivy Towers**. Get inspiration from your plant specialist and create a stunningly colourful and fragrant display! Above and beyond the well-known evergreen ivy (*Hedera*), there are many suitable climbing plants to choose from including:

- Birthwort (*Aristolochia*);
- Wisteria;
- Red Virginia creeper (*Parthenocissus*);
- Clematis varieties;
- Perennial climbing rose varieties;
- Silver Lace vine (*Fallopia baldschuanica*);
- Vitaceae climbing plants (*Vitis*).

Consult your plant specialist or a local landscape gardener for the right choice for your needs.



Ivy Towers with climbing plants decorate the Barcode area, part of Bjørnvika Waterfront in Oslo, Norway. Realised in close co-operation with Iwan Thomson (landscape architect) of Lala Tøyen.





Design: Streetlife  
Protected by int. Model Depots and Patents

## Valley Shelters

The **Valley Shelters** are ideally suited to nature reserves. The use of sustainable materials – CorTen steel and FSC® certified hardwood – give the information boards a natural appearance. The Valley Shelters serve as both an information point and a rest area for hikers and cyclists. The matching wall benches and partition are constructed of fast-growing hardwood with the FSC® label, in the form of round logs. The information display cases are optional.

Minimum order of 5 Shelters.

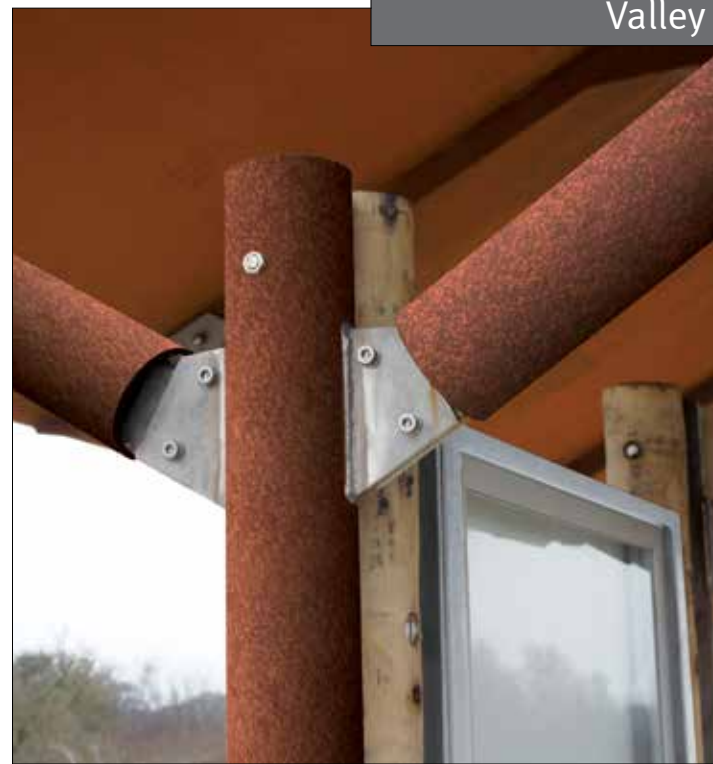

In the dunes between Scheveningen and Katwijk (NL) on the North Sea, Streetlife realised ten Valley Shelters in close co-operation with nature conservation and water supply manager Dunea.





Design: Streetlife  
Protected by int. Model Depots and Patents

## Open Pillars

**Open Pillars** are triangular lighting columns with a lattice-like graphic pattern. The steel structure is made of thick-walled CorTen steel and can be optionally powder coated in a chosen RAL colour. The durable lighting columns can be beautifully combined with climbing plants, resulting in a vibrant new greenscape where vertical green may be otherwise difficult to achieve. The equilateral triangle is 50x50 cm - 20"x20".

The Open Pillars are LED-ready. At the bottom, there is space for a terminal box with uplighter. It is also possible to mount LED strips along the ribs on the inside. LED fixtures are to be delivered and connected by a local electrician.

Heights 450cm and 600cm - 177"x236"

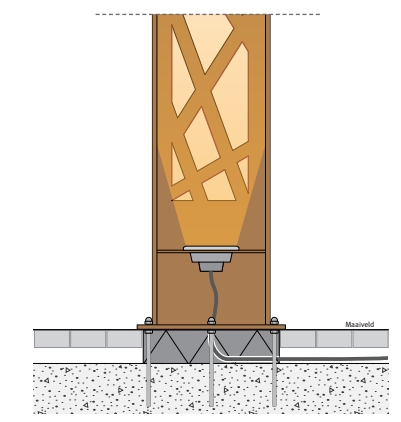

Two methods are available for mounting the pillars. Surface-mounting involves anchoring the pillar to a concrete surface using a triangular metal base. In-ground mounting involves a pavement frame and a removable CorTen grid.



Open Pillars create a special atmosphere on squares or in large courtyards. They are distinct elements that can be optionally combined with LED lighting or climbing plants.





Design: Streetlife  
Protected by int. Model Depots and Patents

Streetlife Brochure 2018 - 2019

This plaza in front of Media City Bergen (Norway) has been upgraded with light-coloured paving and contrasting triangles that mirror the lines of the building. It is here that the triangular Open Pillars have been incorporated and match perfectly with the form language chosen by Smedsvig Landskapsarkitekter.  
Photo: © Pål Hoff

## Open Pillars

With their triangular shape and syncopated geometric patterns, **Open Pillars** lend a space a contemporary and daring look. The structure is made of heavy gauge CorTen steel and can be finished with an RAL-coating.

Open Pillars can be delivered LED-ready, which means they will continue to delight the eye even after the sun goes down. Two methods are available for mounting the pillars. Surfacemounting involves anchoring the pillar to a concrete surface using a triangular metal base. In-ground mounting involves a pavement frame and a removable CorTen grid.

**OP-450-CT**  
450cm | 177"  
**OP-600-CT**  
600cm | 236"

**OP-450-PC**  
177" | 450cm  
**OP-600-PC**  
236" | 600cm







## Parklet System

NEW

The greening of our inner cities and the reduction of the car is a topical issue. Streetlife now offers a very flexible and budget-friendly Parklet System as a solution. It is easy to disassemble and relocate again!

The Parklet System has a modular structure and creates pleasant resting areas on the street, adjacent to the sidewalk. The scarcity of public space is countered by removing existing parking spaces and turning them into 'green' zones.

The deck of CorTen sheets optionally fitted with anti-slip Dots, is placed on a Streetrail system of resistant All Black beams with a module size of 180 x 180 cm - 71" x 71".

There are plenty of furnishing variants to be realized with various products from our Collection, such as green benches, bicycle brackets, box bins, etc. The furnishing elements can be placed easily and flexibly on pre-drilled CorTen floor slabs.



Streetlife's Parklet System is flexible en modular. It's quick and easy to place on the Streetrail underconstruction.



Parklet Configuration 7,2m x 1,8m  
This configuration consists of 4 Big Green Benches with a hard wooden seating rim and 2 Bright Bollards, to mark the corners. In this manner one can create a solid green buffer between street and sitting area!

Design: Streetlife  
Protected by int. Model Depots and Patents

Bright Bollards  
Rough&Ready Big Green Benches  
Rough&Ready Seat Walls

See also:

Streetlife Brochure 2018 - 2019

Big Green Benches mounted onto the Parklet create both a solid buffer and a green fence towards the street. The system is easy to disassemble and to reuse.





Design: Streetlife  
Protected by int. Model Depots and Patents

Solid Meet&Work  
Solid Top Seats  
Shrubtubs

Streetlife Brochure 2018 - 2019

## Parklet System

NEW

To combine our solid Meet&Work-system with the Parklet system an existing terrace can be extended or outdoor workplaces can be created.

Parklet configuration  
7,2m x 1,8m



The Wild Fences have a graphic pattern which delivers a playful sight in the street, while maintaining transparency. The Solid Grille Benches with the light legs complete the 'minimal' look .

Parklet Configuration  
9m x 1,8m



# Index



Solo Bridge All Black  
320



Solo Bridge All Wood  
321



Solo Bridge Cordeck  
322



Zen CorTen Bridge  
338



Country Low Bridge  
340



Crossline Bridges  
342



Bowie Bridge CorTen  
326

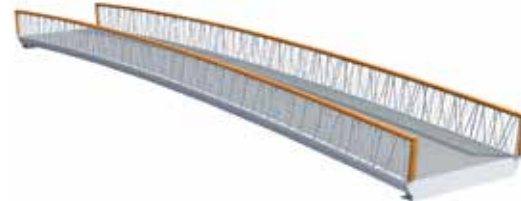

Bowie Bridge  
326



Wild Bowie Bridge **NEW**  
328



Millipede Bridges  
350



Bold Bridge  
352



Chevron Bridge  
354

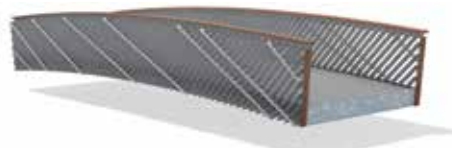

Ona Bridge **NEW**  
332



Wild Willow Bridge  
334



Branches Bridge **NEW**  
336



Single Swan Bridge  
356

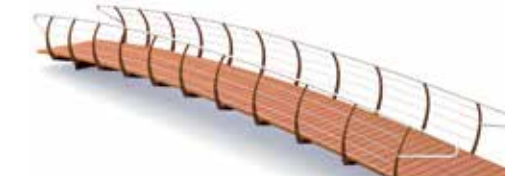

Nautic Bridge  
358



ZigZag Bridge  
360



Jetties  
362



Streetdeck® 40  
370



Streetdeck® 40  
368



Cordeck® 40 Dots **NEW**  
374

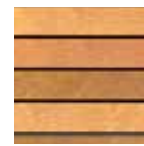

Solideck® 70  
376



Solideck® All Black 70  
378

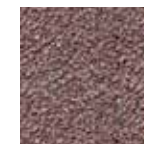

True Deck® 40  
380

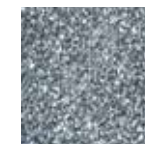

True Deck® 40  
380

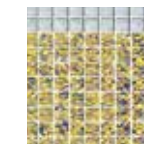

Art Deck® 40  
382

**Category 8**  
**Bridges, Jetties & Decking**

- Bridges
- Jetties
- Decking





## The Bridge Process

In the Bridge Process, Streetlife makes use of a six-step plan: from idea to realization. The diagram shows how Streetlife can assist you by providing the appropriate information at each stage of your layout plan. Short delivery times are possible, average 12-14 weeks after approval of the drawings by the client. Our bridges are delivered almost entirely in prefab state, so that installation usually requires only a few days. Experience has indicated that the delivery time depends more on the decision-making process than it does on the actual manufacturing process.

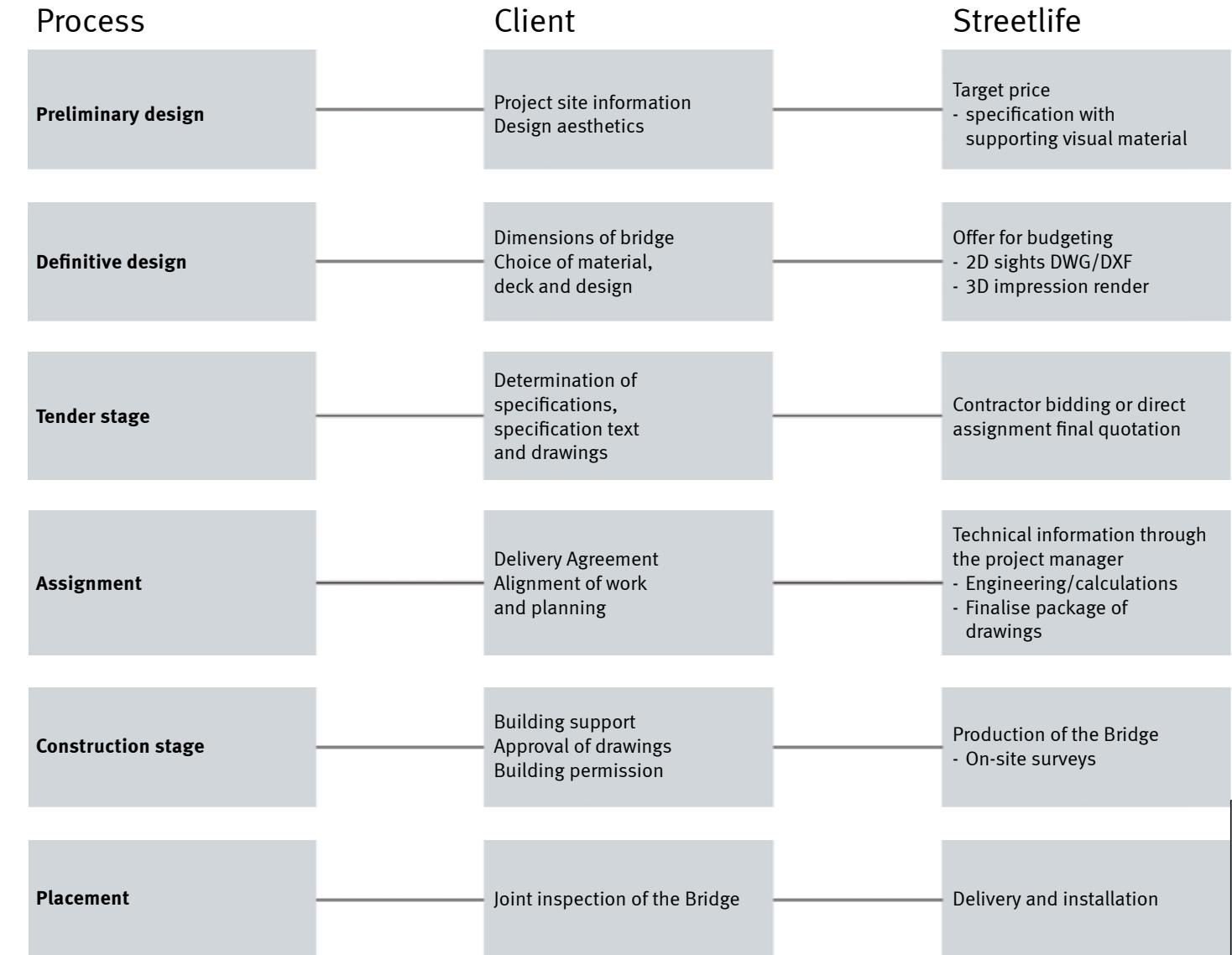





## Partner in Bridges

Streetlife designs and develops durable pedestrian and bicycle bridges. It is possible to produce distinctively designed and contemporary bridges for assembly in virtually any location and in a very short space of time.

You can select and construct your own Streetlife bridge using this brochure. We can also create custom-designed bridges for unusual locations if design and delivery budgets are available for this purpose. Such design projects may also form part of a design and deliver contract.

## Our strengths

- In-house design, engineering, manufacturing and placement
- Drawings, images and statistic calculations for planning permission purposes.
- No upfront design costs for clients. Except for standalone design/presentation orders.
- Clear and effective communications using three-dimensional CAD drawings for accelerating decision-making processes
- Use of sustainable materials, e.g. wood composite decking, CorTen steel and/or glass-fibre reinforced composites.
- Bold, contemporary architectural design.

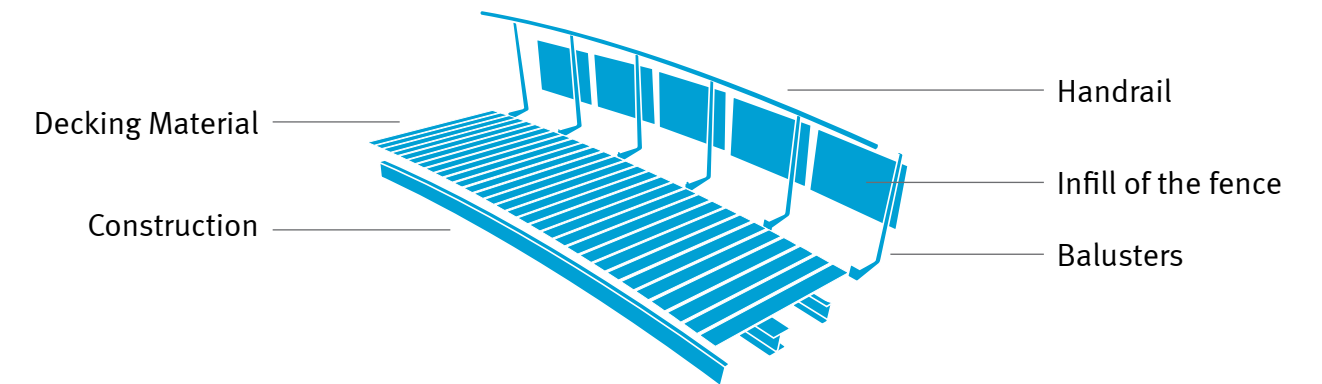

Streetlife Bridge Materials					
Material	Exp. # year	Regular Maintenance / Remarks	Material	Exp. # year	Regular Maintenance / Remarks
Laminated beams	25	Annual cleaning and inspection of wear	Pulltrusion 1:49	60+	Annual cleaning
Galvanized	60	Annual cleaning. Dependant on corrosion class environment and material thickness	Wear Layers	10-15	Biennial inspection
CorTen steel	50	Dependant on corrosion class environment and material thickness	Streetdeck 40	25	Annual cleaning and cleaning of organic material
Powder Coatings	10	Annual cleaning	Cordeck 40	50	Dependant on corrosion class environment and material thickness
SS 316	50+	Annual cleaning	Artdeck	25	-
All Black	25	None: Annual cleaning recommended	FSC Hardwood	15-20	Biennial light sanding





In this sustainable Solo Bridge the entire carrier and deck construction are made of thick-walled CorTen steel plates. The uprights of the fence are of Solid All Black composite beams. Meanwhile the warm brown deck is provided with an anti-slip pattern using the same CorTen plate.

Design: Streetlife  
Protected by int. Model Depots and Patents

Solid Benches  
Solid Picnic Sets  
Solid Green Isles  
See also:

Streetlife Brochure 2018 - 2019

## Solo Bridges

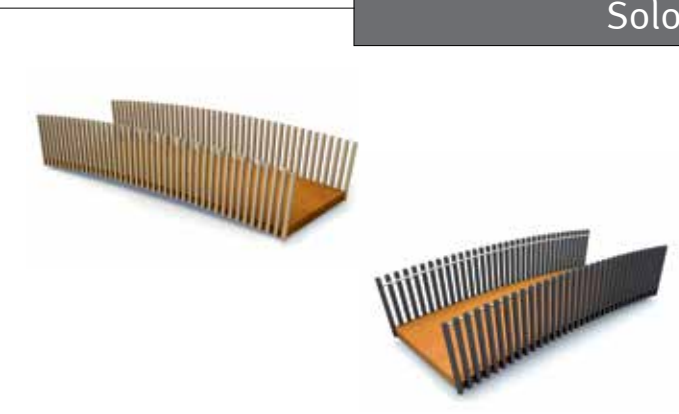

The **Solo Bridge** is contemporary and expressive. Solo Bridges are small pedestrian bridges that can be delivered both flat and slightly arched. The whole load-bearing, decking structure is constructed from a single, thick-walled CorTen steel plate up to 300cm wide - 10ft, and 800cm - 26 ft long. The vertical posts are 70x70mm - 3"x3" and available in FSC® hardwood such as in the Solid range or in recycled black plastic All Black beams. The result is a bridge fence with a distinctly graphic character. The posts are mounted invisibly and remain adjustable after installation.

The Solo fence can optionally be equipped with a stainless steel handrail on the inside (Ø 48mm - 2"). After several years, the horizontal CorTen plate will colour dark brown.

Solo Bridges	
Sizes	L= 4 to 8m, W ≤ 3m - L= 13 to 26ft, W= 10ft
Arching	Flat or Arched
Fence	FSC® wood or All Black slats (7x7cm - 3"x3")
Handrail	Stainless Steel
Decking	CorTen Decking
Construction	CorTen Sheet Material
Norm bridge	Eurocode + nat annex
Norm fence	NPR-CEN/TR 1317-6:2012







This Solo Bridge with Cordeck© and wooden balusters, located in Hvittingfoss, Norway, is 2.5 metres wide and 4 metres long. The ridges on the CorTen decking provide a safe anti-slip surface.

Design: Streetlife  
Protected by int. Model Depots and Patents

Solo Benches  
Solo Picnic Sets  
Solo Green Isles

See also:

Streetlife Brochure 2018 - 2019

## Solo Bridges

**Solo All Wood Bridges** consist of treated European wooden girders, FSC® hardwood posts and decking. These mid-sized pedestrian bridges have a maximum length of 12 metres - 50 ft and a width of 3 metres - 10 ft. Solideck® 70 is mounted onto a wooden support structure made of composite Glulam girders. The 70x70mm - 3"x3" Solid beams that comprise both the bridge deck and fencing fit into each other perfectly. The deck beams can be installed with a deck overhang.

This bridge type is not available in North America.



Solo All Wood Bridges	
Sizes	L= 4 to 12m, W ≤ 3m - L= 13 to 39ft, W ≤ 10ft
Arching	Flat or Arched
Fence	FSC® Solid slats (7x7cm) 3"x3"
Decking	Solideck®
Construction	FSC® Glulam beam
Norm fence	Eurocode + nat annex
Norm fence	NPR-CEN/TR 1317-6:2012



The **Solo All Black Bridges** are made of the Solo fencing combined with the Solideck® 70 decking, consisting of 70x70mm - 3"x3" All Black beams. All Black composite is made of recycled plastics, including waste plastic from the agricultural industry, and is black throughout the entirety of its structure. The All Black Solid beams that comprise both the bridge deck and fencing fit into each other perfectly.

True Composite Bridges	
Sizes	L ≤ 12m, W ≤ 3m, L= 39 to 118ft, W ≤ 10ft
Arching	Flat
Fence	All Black
Decking	Truedeck® 40 in 2 colours
Construction	Pultrusion composite joists
Norm bridge	Eurocode + nat annex
Norm fence	NPR-CEN/TR 1317-6:2012





The large pond in the heart of the city has been revamped based on a design by landscape architect Club L94. A bridge spanning no less than 37 metres now serves to extend the footpaths in the bordering park, thereby completing the connection between the city centre and the railway station area. The warm copper colour of the

custom balusters is reminiscent of Stolberg's industrial heritage as the 'Copper City', with the rhythmic bar pattern of the balusters being based on the Solo Bridge from the Streetlife collection of Bridges & Jetties. The bridge was commissioned by and developed in consultation with the Municipality of Stolberg.



## Bowie Bridges

The **Bowie Bridge** was inspired by the David Bowie song 'Wild is the Wind'. The continuous fencing system of criss-crossed balusters, uninterrupted by posts, creates a fascinating image. The round, stainless steel balusters have varying diameters (max. 30mm - 1.2"), which results in a particularly stiff, strong fence.

This fencing was specifically designed to prevent the possibility of users getting stuck between the balusters. If desired, the baluster pattern can be made denser in order to meet the most stringent safety standards. The Bowie Bridge is available in a slightly arched or flat version. The bridge's maximum, uniformly distributed load-bearing capacity is 5 kN/m<sup>2</sup>.

Bowie Bridges	
Sizes	L= 6 to 16m, W ≤ 3m - L= 20 to 53ft, W ≤ 10ft
Arching	Arched or flat
Fence	SS316 / coated steel / CorTen
Decking	Various decking materials
Norm bridge	Eurocode + nat annex
Norm fence	NPR-CEN/TR 1317-6:2012

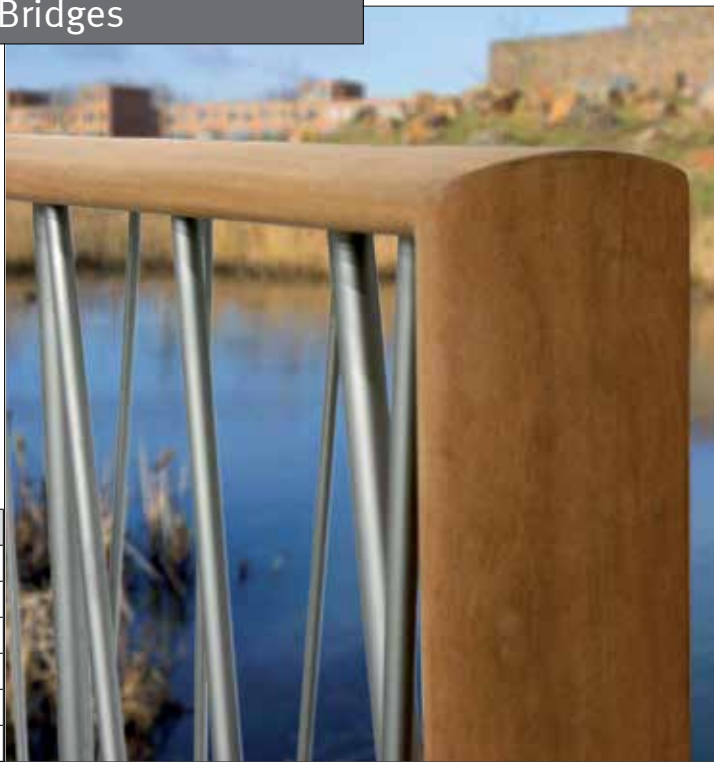

Design: Streetlife  
Protected by int. Model Deposits and Patents

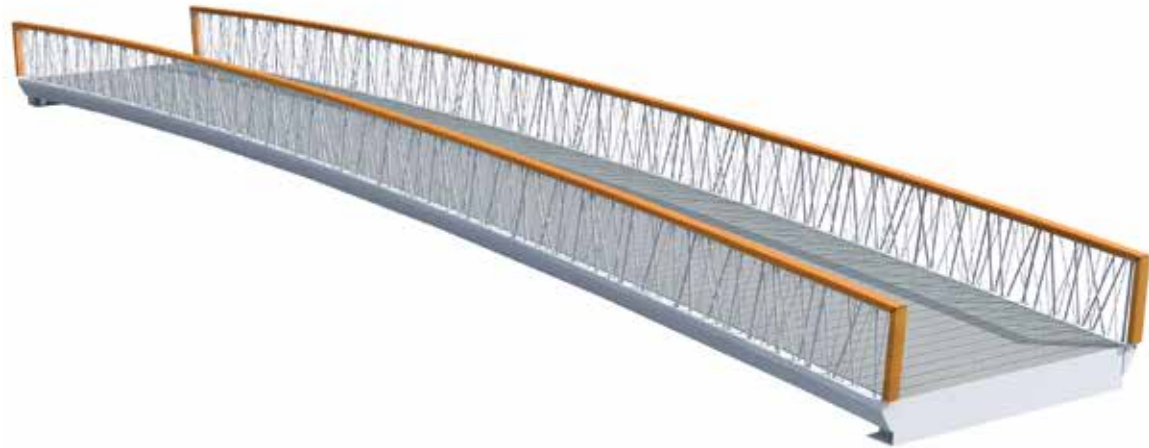

Bowie Bridges are available in a CorTen or coated steel version in which the round balusters are replaced by CorTen steel strips. The CorTen balusters have varying widths resulting in a strong and rigid fencing structure. A robust rounded handrail of FSC® hardwood sets off the fencing and is pleasant to the touch.

Streetlife Brochure 2018 - 2019



This 12-metre-long coated Bowie bridge was installed in the Watertorenpark in Hengelo, the Netherlands. The 3-meter-wide bridge has standing seats in the middle, inviting passers-by to stop for a moment and enjoy the view of the park.





Design: Streetlife  
Protected by int. Model Depots and Patents

## Wild Bowie Bridges

NEW

The continuous fencing of criss-crossed balusters uninterrupted by posts creates a fascinating and natural image. While the standard Bowie bridge features identical steel strips at different angles, the strips used in the **Wild Bowie Bridge** are of varied widths and rotations. This creates a more pronounced natural appearance, with irregularities. The Wild Bowie bridge is available in arched and flat versions with a maximum span of 16 metres. Standard widths of 200 or 300cm. A range of decking materials can be used. Bridge standard: Eurocode + Nat. Annex Fencing standard: NPR-CEN/TR 1317-6:2012

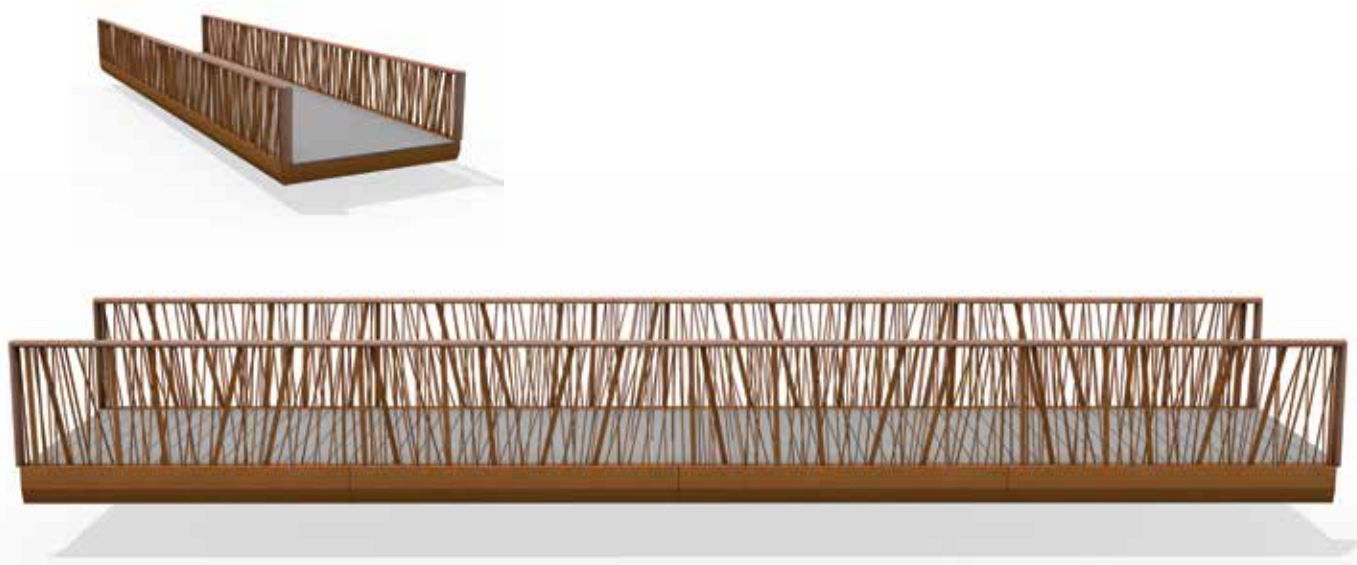
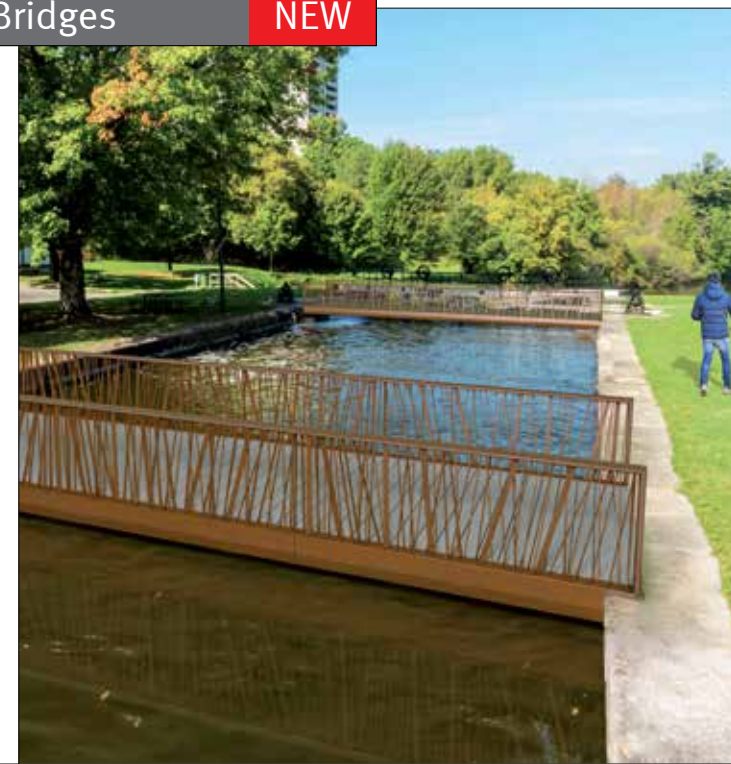

In Woerden, the Netherlands, a flat Bowie bridge serves as the entrance to the Spoorstaete apartment complex. The warm colour of the CorTen steel goes extremely well with the colour of the brickwork.

Streetlife Brochure 2018 - 2019









Design: Streetlife  
Protected by int. Model Depots and Patents

## Ona Bridges

NEW

The **ONA Bridge** features a continuous balustrade with a dynamic graphic design created from CorTen or powder-coated steel strips. The continuous balustrade is topped with an FSC® hardwood handrail. The ONA bridge is flat or slightly arched with a maximum span of around 16 metres. Standard widths of 200 or 300cm. This is a beautiful architectural bridge that can be fitted with various types of decking.

Bridge standard: Eurocode + Nat. Annex  
Fencing standard: NPR-CEN/TR 1317-6:2012

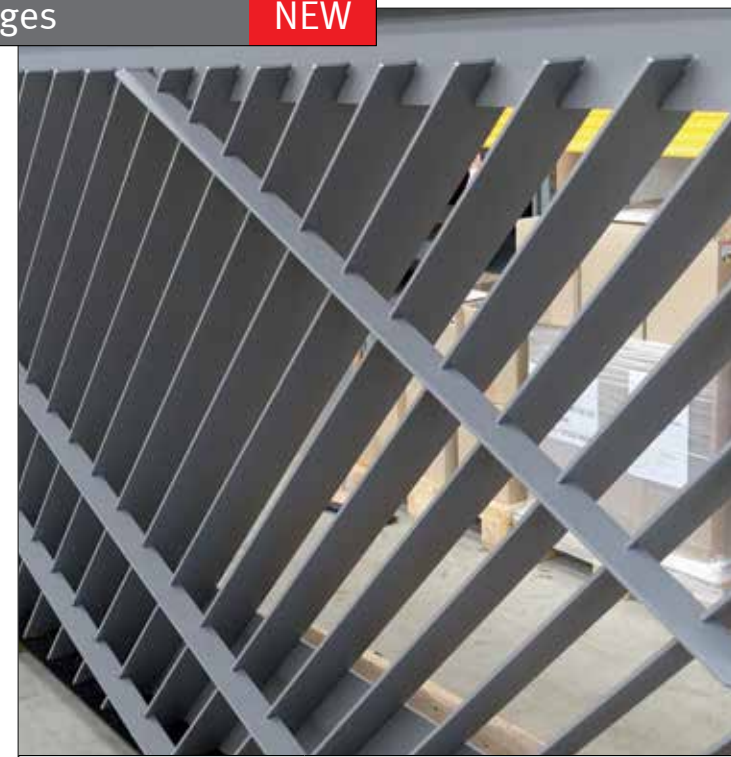

Ona Bridges	
Sizes	L= 9 to 16 m, W ≤ 3 m - L= 29 to 52 ft, W ≤ 10ft
Arching	Arched or flat
Fence	CortenA/ Coated steel
Decking	Div. decking material
Norm bridge	Eurocode + nat annex
Norm fence	NPR-CEN/TR 1317-6:2012

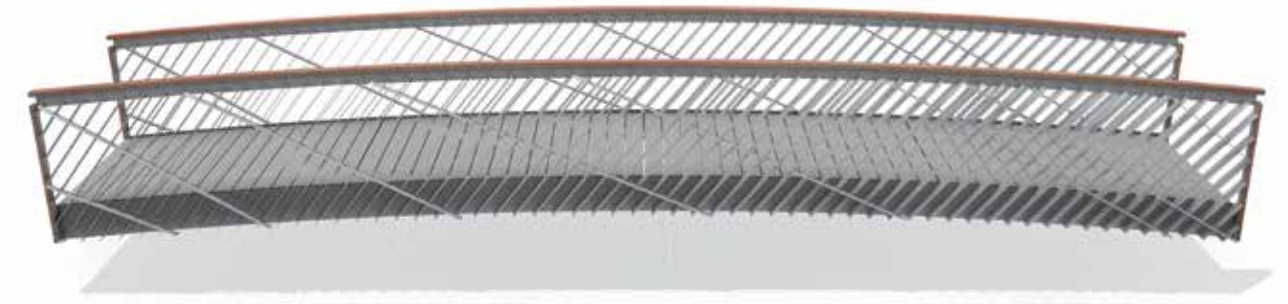

The attractive graphic pattern of the uninterrupted continuous balusters creates an intriguing effect. The Ona Bridge is a good choice for contemporary urban development areas or as an access bridge to an architectonic building.





Design: Streetlife  
Protected by int. Model Depots and Patents

## Wild Willow Bridges

This **Wild Willow Bridge** has a distinct criss-crossed fencing pattern, with alternating CorTen and wooden balusters that run along the sides of the bridge. The framework that encloses the fencing has been adapted for this variation and equipped with FSC® hardwood top railing. With its variety of materials, the Wild Willow Bridge is easily customisable to meet a specific project's needs. The fencing is available in stainless steel, CorTen steel or a coating finish. For information on all our decking systems, please see Category Decking of this brochure.

The Wild Willow fencing pattern is fitted close together, but can also be installed even closer together in order to meet even the strictest safety standards. Wild Willow Bridges are available in a slightly arched or flat model.

This bridge type is not available in North America.



Wild Willow Bridges	
Sizes	L= 6 to 16 m, W ≤ 3 m - L= 20 to 52 ft, W ≤ 10ft
Arching	Flat
Fence	CorTenA with FSC® hardwood or All Black
Decking	Div. decking material
Norm bridge	Eurocode + nat annex
Norm fence	NPR-CEN/TR 1317-6:2012

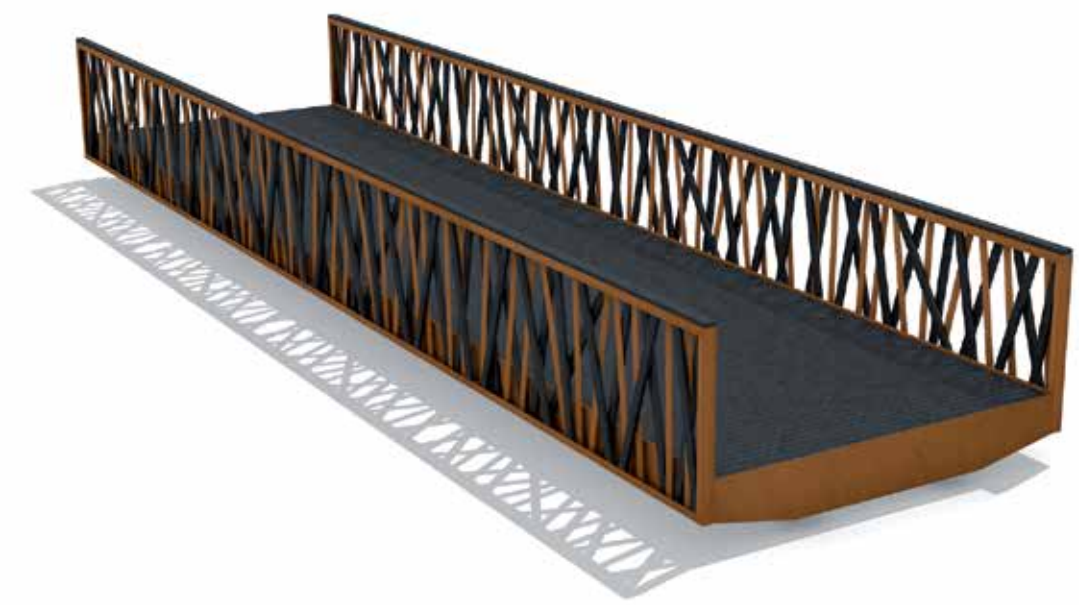





Design: Streetlife  
Protected by int. Model Depots and Patents

## Branches Bridges

**NEW**

The **Branches Bridge** has continuous fencing that meets safety standards. CorTen steel strips branch off and nestle into each other to form stable, semi-closed fencing, which is finished on top with a hand railing. The Branches Bridge projects a very organic and natural image. Available in a slightly arched or flat version with a maximum span of 16 metres. Standard widths of 200 or 300cm. Very attractive with an FSC® hardwood Solideck®70 or Streetdeck® 40 decking.

Bridge standard: Eurocode + Nat. Annex  
Fencing standard: NPR-CEN/TR1317-6:2012

Branches Bridges	
Sizes	L= 6 to 16 m, W ≤ 3 m - L= 20 to 52 ft, W ≤ 10ft
Arching	Arched or flat
Fence	CorTen with Stainless Steel Cables
Decking	Div. decking material
Norm bridge	Eurocode + nat annex
Norm fence	NPR-CEN/TR 1317-6:2012

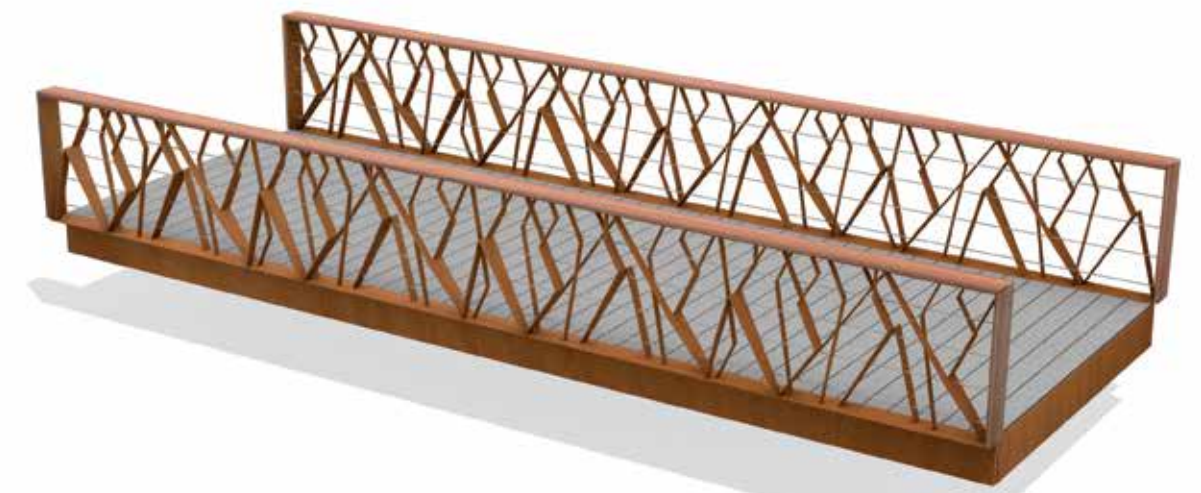

Streetlife Brochure 2018 - 2019





Design: Streetlife  
Protected by int. Model Depots and Patents

## Zen CorTen Bridges

**Zen CorTen Bridges** are small pedestrian bridges with a short span of up to eight metres. The whole load-bearing, decking structure is constructed from a single, thick-walled CorTen steel plate up to 200cm - 7 ft wide and 800cm - 26 ft long. The low fence combines simplicity with a certain oriental style. The CorTen steel railing is capped with FSC® hardwood, and the projecting ends have been rounded off substantially. After several years, the horizontal CorTen plate will colour dark brown. A dot-pattern can be incorporated in the decking for extra grip.



Zen CorTen Bridges	
Sizes	L= max. 8m, W ≤ 2m - L= max. 26ft, W ≤ 7ft
Arching	Arched
Fence	CorTen
Decking	CorTen deck
Norm bridge	Eurocode + nat annex
Norm fence	NPR-CEN/TR 1317-6:2012







The **Country Bridge** has a rustic, rural design. The simplicity of the design blends perfectly with the beautiful industrial fences. Three Low Country Bridges have been placed in 't Nieuwelant Park in Vlaardingen (NL).

Design: Streetlife  
Protected by int. Model Depots and Patents

Rough&Ready Benches  
Rough&Ready Seating Isles  
Rough&Ready Shades  
See also:

Streetlife Brochure 2018 - 2019

## Country Bridges Low

**Country Bridges Low** have a functional design and blend easily in with their surroundings. Their understated design disguises the quality detailing. The look of the low balusters was based on Streetlife's Rough&Ready product range. The sturdy baluster beam is available both in FSC® hardwood and All Black versions.

With their low fencing, these bridges harmonize perfectly with open landscapes and park environments. The 30cm - 12" high fencing works best in surroundings with limited height differences between water and ground level. This bridge is perfect for rural environments with bridge spans of up to 12 metres - 38 ft.



The Country Bridges Low are equipped with a low fence, 30cm high. The Rough & Ready Baluster system comes in a rigid beam of FSC® hardwood (7x15cm - 3"x6") or in a black synthetic material made of recycled agricultural plastic sheeting. These reinforced All Black beams are extra strong and rigid. In addition, Streetlife offers a variety of decking materials including Streetdeck®, Truedeck® and Solideck® made of FSC® hardwood. The fence is beautifully detailed with laser-cut supports.

Country Bridges Low	
Sizes	L= 4 to 12m, W ≤ 3m - L= 13 to 39ft, W ≤ 10ft
Arching	Flat
Fence	FSC® hardwood or All Black
Decking	Streetdeck®40
Norm bridge	Eurocode + nat annex
Norm fence	NPR-CEN/TR 1317-6:2012





Design: Streetlife  
Protected by int. Model Depots and Patents

Rough&Ready Benches  
Rough&Ready Seating Isles  
Rough&Ready Shades  
See also:

Streetlife Brochure 2018 - 2019  
343

## Country Bridges High



Flat **Country Bridges High** might be basic in their form, but really perform in terms of function. The distinctive Rough&Ready beam is fitted on industrial-looking thermal diffusion galvanized posts, and can be made of FSC® hardwood or All Black, a black synthetic material made of recycled plastics. Stainless steel cables run parallel to the beam, reinforcing the industrial design. To achieve a warmer look, the bridge can be fitted with CorTen steel posts. The support structure for the bridge is a simple load-bearing construction.



Country Bridges High	
Sizes	L= 4 to 10m, W ≤ 3m - L= 13 to 33ft, W ≤ 10ft
Arching	Flat
Fence	FSC® hardwood or All Black
Decking	Streetdeck®40
Norm bridge	Eurocode + nat annex
Norm fence	NPR-CEN/TR 1317-6:2012





This stunning Crossline CorTen Bridge can be found at 't Nieuwelant Park in Vlaardingen (NL). The robust CorTen fences with criss-crossed balusters blend in harmoniously with the row of multi-stemmed trees!

Design: Streetlife  
Protected by int. Model Depots and Patents

Streetlife Brochure 2018 - 2019

## Crossline Bridges

**Crossline CorTen Bridges** are flat bridges with segmented fencing. The segmented fencing frames give these bridges a sophisticated-outdoor look. The robust frames are made of CorTen and covered with an FSC® hardwood railing. The infill is available in horizontal stainless steel cables or criss-crossed stainless steel balusters. The varied materials and dimensioning of the infill results in an engaging contrast with the sturdy frames. Lighting can be placed underneath the railing for a subtle effect. This concealed placement ensures diffuse lighting that will not blind passers-by.



Fence module with stainless steel cables



Fence module with Criss-cross balusters



Optionally available with subtle bridge surface lighting in the fencing.





Design: Streetlife  
Protected by int. Model Depots and Patents

## Crossline Bridges

The fencing modules of the **Crossline CorTen Bridges** are available with various inserts. The Crossline bridge depicted below, with horizontal stainless steel cables, creates a clean, transparent image. The underside of the CorTen fencing modules can be delivered LED-ready. As an optional add-on, LED fixtures can be installed underneath the railing to subtly light up the fencing and bridge deck: an attractive solution, in terms of both light technology and aesthetics.



Crossline CorTen Bridges	
Sizes	L= 6, 9 to 12m, W ≤ 3m - L= 20, 30 or 40ft, W ≤ 10ft
Arching	Flat
Fence	CorTen
Decking	Various decking materials
Norm bridge	Eurocode + nat annex
Norm fence	NPR-CEN/TR 1317-6:2012



Streetlife Brochure 2018 - 2019





Design: Streetlife  
Protected by int. Model Depots and Patents

## Bespoke Crossline Bridges

For projects requiring longer bridge spans, Streetlife builds its bridges out of prefabricated segments that have been specially-designed to bear extra load between support points. In 2015, Havelberg was one of five cities to host the German national biennial horticulture show, Bundesgartenschau or BUGA. The organisers selected the **Crossline Bridge** with stainless steel cables in a criss-cross pattern to serve as a pedestrian bridge over the Flehte valley and allow access between exhibitions areas placed around the city centre. The design concept called for a slender and transparent bridge that would not obstruct the view of the historic cityscape and provide a quaint and harmonious feel.



The required bridge span was about 40 meters - 131 ft. Streetlife designed a bridge in three segments of 12, 15 and 12 metres - 39 ft, 49 ft, 39 ft with slender V-shaped columns. The columns were entirely made of heavy gauge CorTën steel installed on concrete blocks. The bridge surface was 2.5 metres - 8 ft wide with a minimal slope of 0.7 degrees, making it easily accessible to all visitors. The sturdy crossline fencing segments invited visitors to lean against them to admire the view. After design approval, Streetlife worked with a local structural design engineer and, in accordance with German building regulations, a second local specially-licensed engineer called a Prufstatiker in order to carry out the project's technical specifications.



The bridge segments and columns were produced in the Netherlands and the foundations were built by a local builder to match the engineer's specifications. The three bridge segments and two columns were then stored in Havelberg for the winter so that a natural patina rust could form on the bridge in time for the opening. The Streetlife team installed the bridge in two days with the help of a local crane company.



Working together in a small project team allowed Streetlife to stay close to the original vision for the bridge. Streetlife believes in a narrow gap between design concept and project implementation. By working with local parties during the installation phase, we also maintain excellent on-site efficiency. The **Crossline Buga 2015 Bridge** is an great example of how well a scalable bridge concept works on international projects.

Streetlife Brochure 2018 - 2019  
349

The organisers of the BUGA selected the Crossline Bridge with stainless steel cables in a criss-cross pattern to serve as a pedestrian bridge over the Flehte valley.





Design: Streetlife  
Protected by int. Model Depots and Patents

Streetlife Brochure 2018 - 2019

## Millipede Bridges

The **Millipede Bridge** has angularly-bow shaped CorTen supports. It is extra-wide due to its outwardly curved shape. Millipede Bridges are available in a CorTen version. The angular-bow shape of the posts perfectly brings out the hues in the CorTen patina. The CorTen posts require little maintenance over the life span of the bridge, making this bridge a good investment in terms of both style and budget. The Millipede CorTen Bridge shown here is fitted with Streetdeck®, but you can choose any of our decking solutions. Available in Cordeck® with anti-slip Dots.

Streetlife delivers its CorTen products unweathered allowing a lovely variety of hues to appear in the first year of use. CorTen turns a deep brown shade over time.



Millipede Bridges CorTen	
Sizes	L= up to 16m, W ≤ 3m, L= up to 53ft, W ≤ 10ft
Arching	Arched
Fence	CorTen
Decking	Various decking materials
Norm bridge	Eurocode + nat annex
Norm fence	NPR-CEN/TR 1317-6:2012







Design: Streetlife  
Protected by int. Model Depots and Patents

Streetlife Brochure 2018 - 2019

## Bold Bridges

**Bold Bridges** are characterised by their sturdy balusters with clean-lined detailing. A bold, oval-planed hardwood handrail on a narrow column completes this architecturally-detailed fencing. A robust stainless steel tube railing (Ø 10cm - 3.9") makes an attractive alternative handrail. The posts are thermal diffusion galvanized and can be optionally power-coated or made of CorTen steel. Bold Bridges have overhanging posts, invisibly mounted on a closed-edge girder. Horizontal stainless steel cables with tensioners complete the fencing.



Bold Bridges	
Sizes	L= 6 to 16m, W ≤ 3m - L= 20 to 53ft, W ≤ 10ft
Arching	Flat or Arched
Fence	Steel coated / Corten / galvanized steel
Decking	Various decking materials
Norm bridge	Eurocode + nat annex
Norm fence	NPR-CEN/TR 1317-6:2012



The deck construction of the **Bold Bridge CorTen** consists of profiles in Cordeck®40 Corten, in order to create a warm brown overall look and feel. To create an additional anti-slip deck dots can be fitted in a regular pattern.





Design: Streetlife  
Protected by int. Model Depots and Patents

## Chevron Bridges

**Chevron Bridges** are characterised by their raw, outdoor look and feel. Their fencing consists of angular balusters made entirely out of CorTen steel. The fencing is equipped with a 316 stainless steel handrail rounded on the inside. The bridge's decking is also made

out of CorTen steel: Streetlife's Cordeck®40. This decking can be equipped with an slip-resistant pattern dots for even more grip. Over time, the bridge will turn different colour shades depending on climate and intensity of use.



Chevron Bridge	
Sizes	L= 6 to 16 m, W ≤ 3m - L= 20 to 53 ft, W ≤ 10 ft
Arching	Flat or Arched
Fence	CorTen or Powdercoated steel
Decking	Cordeck®40
Norm bridge	Eurocode + nat annex
Norm fence	NPR-CEN/TR 1317-6:2012

Streetlife Brochure 2018 - 2019





Design: Streetlife  
Protected by int. Model Depots and Patents

Streetlife Brochure 2018 - 2019

## Single Swan Bridges

**Swan Bridges** are equipped with the Swan, CorTen or RAL-coated fencing system. Single fencing gives the bridge an extra-wide look and feel and improves accessibility. The CorTen balusters measure 110cm - 43" in height and are equipped with a round handrail of hardwood or stainless steel.

The fencing is fitted with full-length stainless steel cables or partially fitted with CorTen mesh panels to meet international safety standards. The bridge is finished with beautifully curved CorTen panels along the load-bearing structure. This design makes the fencing difficult to climb over.

These Swan Bridges can bridge a maximum span of 16 metres - 52 ft. The width is a standard two or three metres. Maximum uniformly distributed load-bearing capacity of five kN/m<sup>2</sup>.

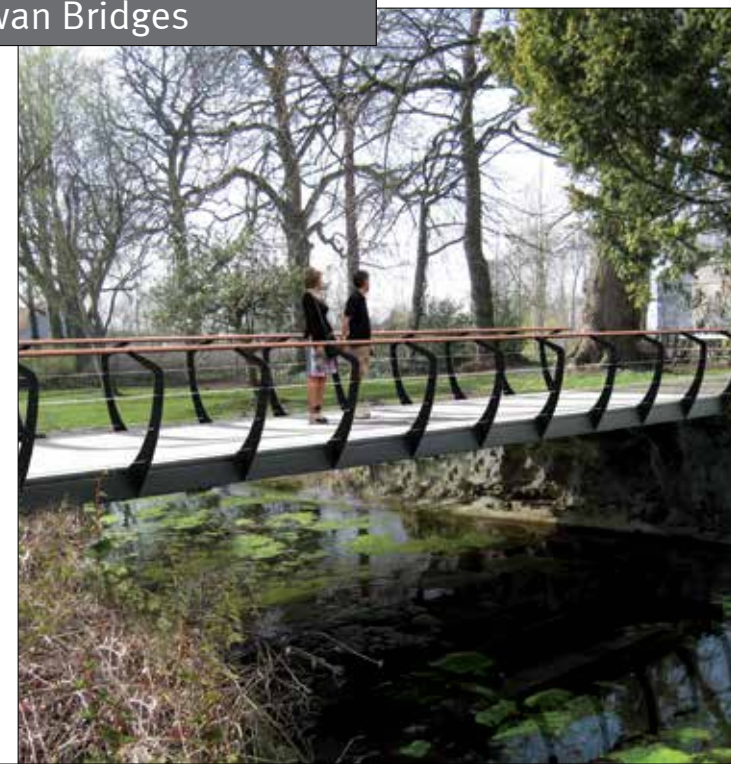

Single Swan Bridges	
Sizes	L= 6 to 16m, W ≤ 3m - L= 20 to 53ft, W ≤ 10ft
Arching	Flat or Arched
Fence	CorTen or coated steel
Decking	Various decking materials
Norm bridge	Eurocode + nat annex
Norm fence	NPR-CEN/TR 1317-6:2012





This 30-metre-plus long striking Inline Bridge has been placed in a new residential area in Sneek (NL). The two supports have been installed from the bank. The many boats that pass under the bridge were accounted for by designing a spacious passage.

Design: Streetlife  
Protected by int. Model Depots and Patents

## Shortline Nautic Bridges

The Nautic fence of the **Shortline Nautic Bridge** consists of curved, galvanized steel, CorTen or double powdercoated steel balusters with various continuous stainless steel cables and tensioners. Their curved design and height (110cm - 4") make these fences particularly difficult to climb over. Children would have to be able to counter their own weight in order to climb these fences.

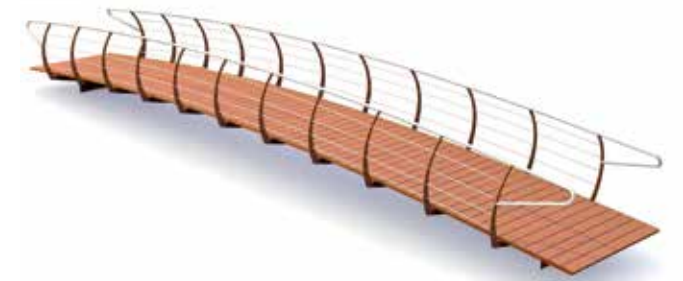

### Shortline Nautic Bridges

Sizes	L= 6 to 16m, W ≤ 3m - L= 20 to 53ft, W ≤ 10ft
Arching	Flat or Arched
Fence	Corten, coated or galvanised steel
Decking	Various decking materials
Norm bridge	Eurocode + nat annex
Norm fence	NPR-CEN/TR 1317-6:2012

Streetlife Brochure 2018 - 2019







This **Shortline Bridge** with ZigZag fence has been installed in Bergen (NO) to provide access to a local park. One bridgehead has been elevated to create an attractive connection to the bank.

Design: Streetlife  
Protected by int. Model Depots and Patents

## Shortline ZigZag Bridges

The **Shortline Bridge** with **ZigZag** Fencing has a contemporary feel. The bars in the fencing run from the tubular handrail right down to the sturdy bottom rail. The bars are alternately fixed to the bottom rail, creating the subtle 3D ZigZag effect with a 'fringe' on the base. The fencing is closed and difficult to climb over, meeting most international standards. This is a hard-wearing bridge made of thermal diffusion galvanized steel. The handrail is constructed of 316 stainless steel. The ZigZag modules can be powder-coated in RAL colour if desired.



### Shortline ZigZag Bridge

Sizes	L= 6 to 16m, W ≤ 3m - L= 20 to 53ft, W ≤ 10ft
Arching	Flat or Arched
Fence	Coated or galvanised steel
Decking	Various decking materials
Norm bridge	Eurocode + nat annex
Norm fence	NPR-CEN/TR 1317-6:2012



Streetlife Brochure 2018 - 2019





Design: Streetlife  
Protected by int. Model Depots and Patents

## Floating Jetties Curved

Waterways are increasingly attracting urban development projects. Boulevards and open water provide cooling rest and recreational areas amid the bustling city. Streetlife is introducing a system of **Floating Jetties** in both Curved and Straight models. The jetties are fitted with FSC® hardwood Solideck®70 decking, making them the perfect match for Solid Crosswise Benches. The Floating Jetties system uses modules made of aluminium and filled with 80% foam. The floating modules are then hinged together and the jetty structure is stabilised on poles.

This product is not available in North America.



Floating Jetties Curved	
Sizes	W= max. 3m - W= max. 10 ft, +/- 0,5m above surface
Curve	Outer radius min. 11m - 433" with a 2m - 79" wide deck
Connection	Bespoke in consultation
Decking	Solideck®70 / Cordeck®40 / Streetdeck®40

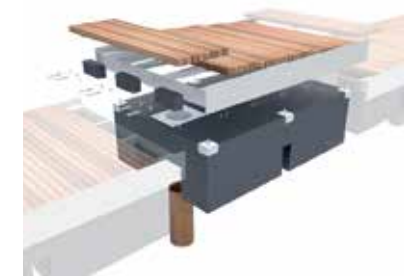

Streetlife Brochure 2018 - 2019  
363





Design: Streetlife  
Protected by int. Model Depots and Patents

## Floating Jetties

In addition to its curved jetties, Streetlife is introducing **Floating Jetties** in straight form. The jetties are fitted with FSC® hardwood Solideck®70 decking, making them the perfect match for Solid Crosswise Benches. The Floating Jetties system uses modules made of aluminium which are filled with 80% foam. The floating modules are then hinged together and the jetty structure is stabilised on poles.

This product is not available in North America.



Floating Jetties	
Sizes	W= max. 3m - W= max. 10 ft, +/- 0,5m - 20" above surface
Connection	Bespoke in consultation
Decking	Solideck®70 / Cordeck®40 / Streetdeck®40





## Decking Systems

Choosing decking that is both stylish and resistant to wear is important to any project. The Streetlife 2018-2019 Collection includes five unique decking systems that are designed to perfectly complement Streetlife's bridges and jetties in both their form and function. The different materials available in our decking systems allow for a variety of looks, from eye-catching to neutral. Streetlife's decking is also durable, making it a smart investment.

Choose from the following five decking systems:

- Streetdeck®40 (\*)
- Cordeck®Dots
- Solideck®70 FSC® and All Black
- Truedeck®40 (\*)
- Artdeck®40 (\*)

\*This product is not available in North America.

All the decking systems are based on intellectual property rights.

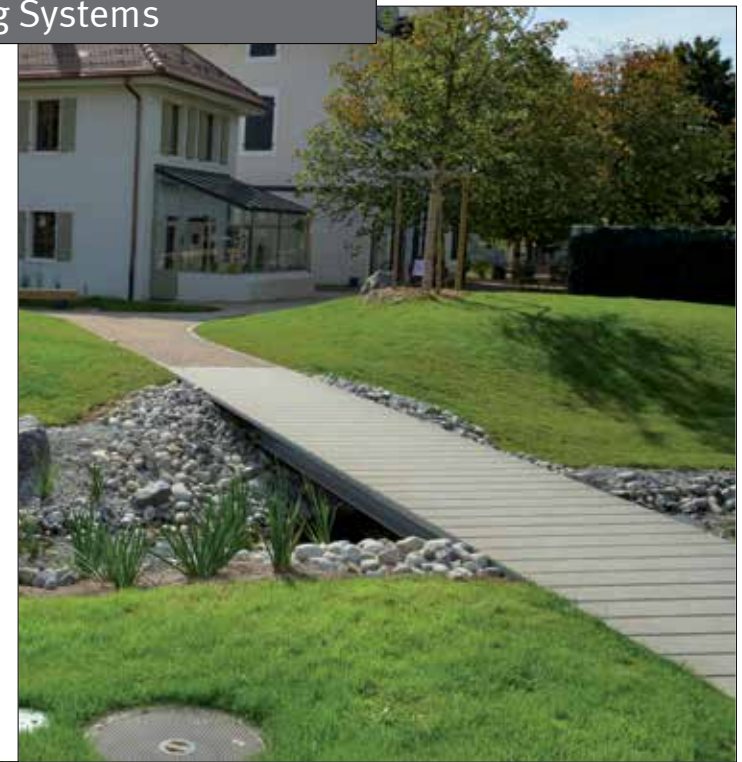

Streetlife decking is sturdy in its dimensions. With a thickness of 40mm or more, our decking can support more weight while requiring fewer underlying support beams. Streetlife decking systems are perfect for slow traffic bridges and jetties. In addition, they are also ideally suited for platforms or roof terraces.

All decking systems have a quick and invisible mounting system detailed in the specifications. If you have any questions regarding decking types, mounting methods, slip resistance, applications, or more, please do not hesitate to contact us. If you would like to request an estimate, we recommend sending a first technical drawing showing the number of required square metres.

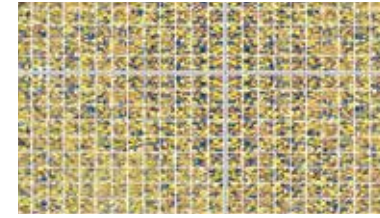
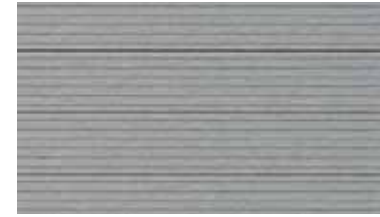





## Streetdeck®40

**Streetdeck®40** is an environmentally-friendly alternative to hardwood. It is not only sustainably-sourced, but also more slip resistant and more durable than hardwood. This decking has a clean-lined, contemporary look and is available in two colours. Streetdeck®40 is made of a composite wood comprising 75% chipped waste wood and 25% synthetic material.

During the manufacturing process, the wood chips are completely incorporated into the synthetic material, producing a product that is resistant to mould and algae growth. In addition, Streetdeck®40 never splinters or cracks, making it the perfect decking for bare feet. It is maintenance-free and softens in colour over time once installed in an outdoor area. Streetdeck®40 is patented. The wood used in its manufacture is 100% PEFC certified European wood.

Streetdeck®40 is available in 2 UV-stable colours: Medium Grey and Russet.

This product is not available in North America.

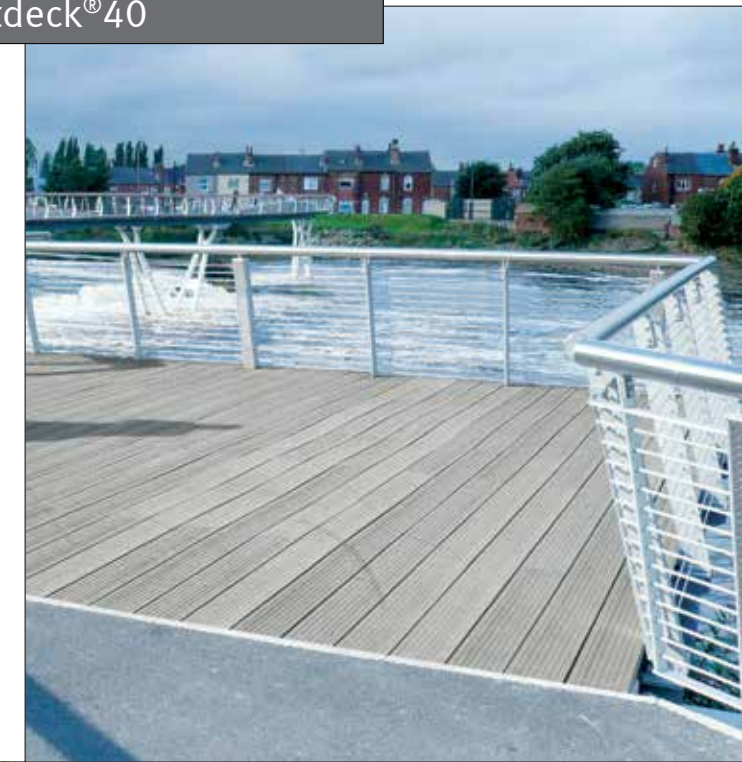

### Streetdeck®40 basic specifications:

- Profile size 19x4cm, maintain 15 mm gap between face ends
- Standard lengths of 2, 3, 4 and 5 metres
- Low self-weight: 27.5 kg per m<sup>2</sup>
- Blind mounting, from below with hammerhead bolts and beam clips on steel profiles
- Blind mounting from above with screw clamps secured to wooden joists
- Maximum centre-to-centre span of 100cm (at 5 kN/m<sup>2</sup> and minimum of 3 points of support)
- Point load 10x10cm: 7kN max.
- Slope of approx. 2°
- Ventilated base structure required
- Splinter-free, ideal for bare feet

Assembly manual including technical specifications available on request.

Design: Streetlife  
Protected by int. Model Depots and Patents

Streetlife Brochure 2018 - 2019





Design: Streetlife  
Protected by int. Model Depots and Patents

## Streetdeck®40

### Slip resistance

Streetdeck® has been awarded a safety rating by the Wuppertal Safety Threshold and NTA7909:2004. It especially outperforms wood in wet conditions. Slip resistance for pedestrians was tested using the Floor Slide Control 2000 print with both a rubber and synthetic sole. We recommend mounting Streetdeck®40 cross-wise in relation to the dominant walking direction.

### Streetdeck®40 ESR: Extra Slip Resistant

For cases where greater slip resistance is necessary, such as sloping surfaces or sharp bends in bicycle paths or crossings, Streetlife has created Streetdeck®40 ESR.

Streetdeck®40 ESR boards have a layer of fine grit applied to the surface of the wood composite using UV-stable and elastic composite resin. The colour of the grit is matched to complement the colour of the Streetdeck®.



### Durability & resistance to wear

The durability of Streetdeck®40 is extremely good and even superior to many hardwood types. In tests, Streetdeck® scored significantly better than Bangkirai tropical hardwood. The material is uniform throughout allowing natural wear to have no effect on look or function.

### Maintenance

Proper maintenance is essential to any decking material. Streetdeck®40 will not rot, but will need to be cleaned of organic and moisture-retaining substances in order to ensure it retains its shape and slip resistance. In most cases, annual cleaning with pressurized water is sufficient, preferably in autumn. We will be glad to assist you in creating a proper maintenance schedule.





Design: Streetlife  
Protected by int. Model Depots and Patents

Streetlife Brochure 2018 - 2019

## Cordeck® Dots

NEW

The **Cordeck®Dots** profiles are made of CorTen steel plate. A relief of round dots is arranged in a regular pattern and provides good grip: the decking is extra slip-resistant. Cordeck®Dots Decking has a very long lifespan.

The maximum length is 300cm  
 The maximum c.t.c. distance for supports is 150 cm.  
 Cordeck®Dots profiles are invisibly attached by clamping them to the frame. Mounting hardware is included.

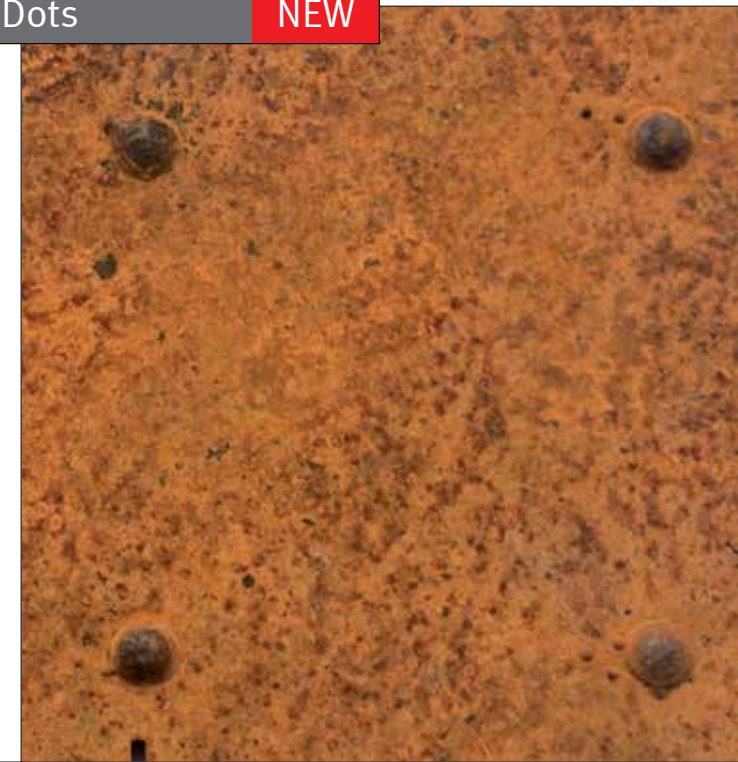

Cordeck®40	
Size (wxh) <b>Cordeck®Dots</b>	180 / 240 / 320x40mm
Length	max. 300cm
Material	CorTenA
Weight	56 kg/m <sup>2</sup>
Montage	h.o.h. < 150cm
Invisible Montage	with Streetlife hammer-head bolts and clamping plates
Max. distributed load	5 kN/m <sup>2</sup>
Notch height	> 50 yeear



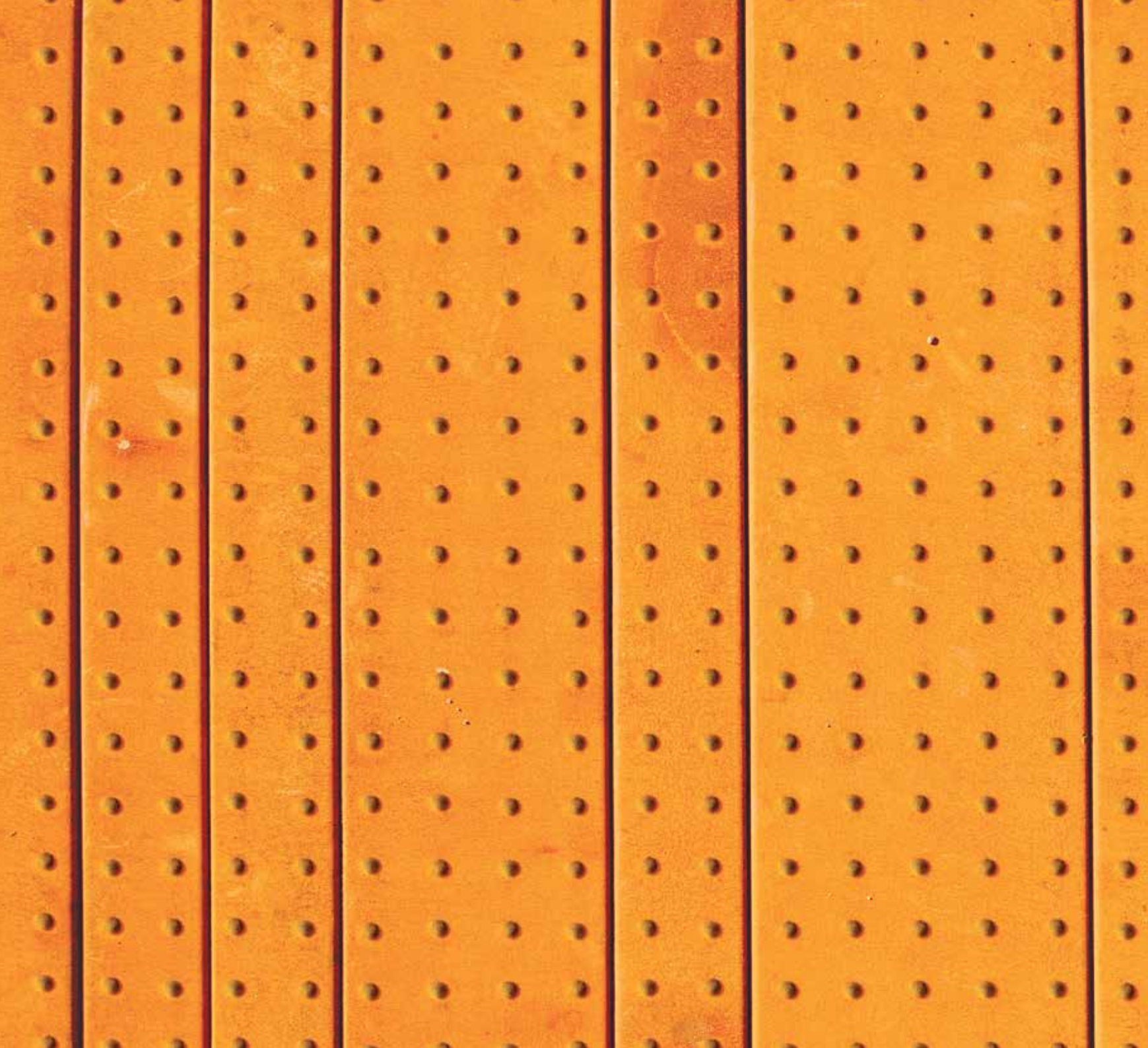

Design: Streetlife  
Protected by int. Model Depots and Patents

## Cordeck® Variados

**Cordeck® Variados** is especially suitable for use on large surfaces or bridges with plain-style fencing. This results in an interesting look with a tension between the regular pattern of the dots and the playful irregularity of the boards. In its colour composition, CorTen is a warm, polychrome brown-orange. The colour of the decking will change to a darker brown over time and, depending on how intensely it is used, the decking itself will start to show usage patterns.

Cordeck® Variados (max. length 3 metres) has 4 board widths, all with the same uninterrupted anti-slip pattern:

Cordeck®2: 180mm - 7.1" wide (with two rows of notches)

Cordeck®4: 300mm - 11.8" wide

Cordeck®5: 360mm - 14.2" wide

The boards are available in any desired combination. Cordeck® Variados is invisibly mounted on a steel or wooden base structure using hammer-head bolts and clamping plates.

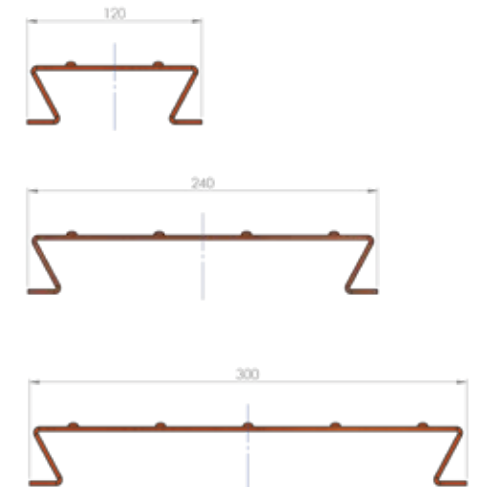
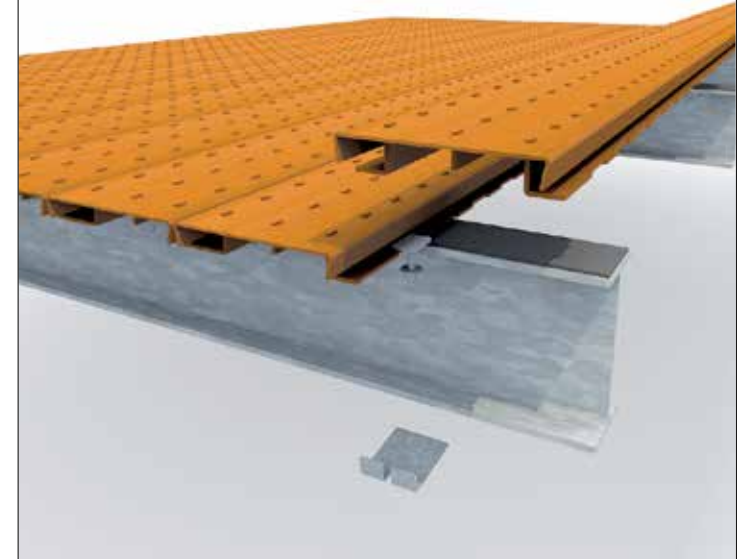





Design: Streetlife  
Protected by int. Model Depots and Patents

## Solideck®70 Wood

**Solideck®70 Wood** is Streetlife's top of the line decking system. It is a particularly solid and strong decking system made of 7x7cm -3"x3" 100% FSC® hardwood slats with the highest durability rating. The slats are top-mounted and invisibly clipped into place using fastening clamps. This makes assembly fast and easy. For an extra rugged look, the 7x7cm slats can be installed with a deck overhang.

Available in lengths of 200 and 300cm -79" and 118".



The Solideck®70 Wood deck system is ideal for use on jetties, bridges and platforms. Fastening clamps allow it to be assembled quickly and easily.



Solideck®70 slats are available in lengths of 200 and 300 cm - 79" and 118". Approximately twelve slats per metre.



Endklemme aus Kunststoff



T-Klemme aus Kunststoff

Streetlife Brochure 2018 - 2019  
377





Design: Streetlife  
Protected by int. Model Depots and Patents

Streetlife Brochure 2018 - 2019  
379

## Solideck®70 All Black

**Solideck®70 All Black** is a distinctive, environmentally-friendly alternative to FSC® wood. All Black is made of recycled plastics and is UV stable. Named after the dying process that imparts the colour evenly into the grain, All Black is a sturdy decking solution with a long life. The understated look of All Black can create strong contrasts in any landscape design.

Solideck®70 All Black does not rot, is mould resistant and requires no maintenance. Though it will not wear, we do recommend scheduling one cleaning per year to help the deck retain its high-quality look.

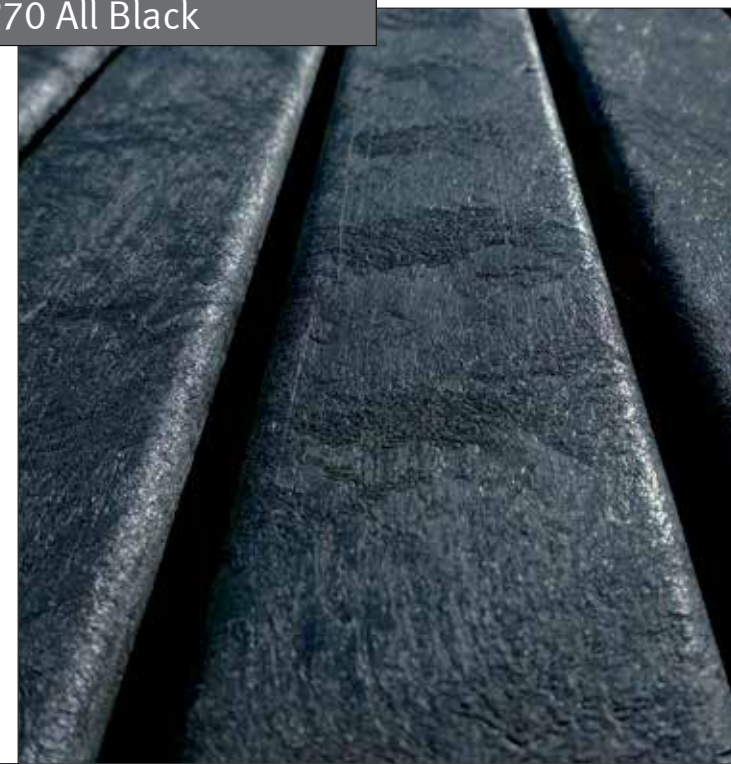

Solideck®70 is coarse in structure, scoring 88 dry and 66 wet in accordance with NEN2873 on the Leroux scale. The surface becomes more matt over time.  
Solideck® All Black is available in a board length up to 250cm - 98".  
Centre-to-centre span: 100cm - 39" with 3 supports.



Solideck®70 is mounted on a steel base structure or onto wood-composite joists. Both methods are fast, easy and show no visible mounting elements.





Design: Streetlife  
Protected by int. Model Depots and Patents

## Truedeck®40



**Truedeck®40** is a complete composite decking system comprising pultrusion profiles, which are blindly anchored and finished with gravel. As the composite resin of the pultrusion profiles is almost identical to the bonding resin of the coloured gravel, there are no differences in expansion, thus reducing maintenance to zero. There is a choice between two types of Truedeck® profiles: Open or Closed, both 4cm thick.

Truedeck® is lightweight (20 kg/m<sup>2</sup>), but at the same time very strong with a maximum accidental vehicle load of 12 tonnes. Truedeck® is designed in accordance with EN1991-2 and CUR96. This product is not available in North America.



Truedeck®40- 256mm / 500mm	
Sizes (wxh)	256 x 40mm/500 x 40mm - 100"x16"/197"x16"
Lengths	200 / 300 / 400 / 500cm - 79"/118"/157"/197"
Net weight	20 kg/m <sup>2</sup>
Max. distributed load	5 kN/m <sup>2</sup>
Max. maintenance vehicle load	5.000 kg
Max. unintended vehicle load	12.000 kg
Wear-layer	Colour and grain size in consultation
Material composition glass fibre – resin	60% - 40%
Life span plank	> 50 year
Life span wear-layer	10 year

Streetlife Brochure 2018 - 2019





Design: Streetlife  
Protected by int. Model Depots and Patents

## Artdeck® 40

**Artdeck®** is a galvanized steel grid of 33x33mm - 1"x1" mesh filled with resin-bounded rubber granulate, resulting in a sound-absorbing deck covering. In terms of form, Artdeck® produces a strong graphic image. Artdeck® is very slip-resistant, requires little maintenance and is completely porous. Artdeck® is applied in modules of 120x100cm - 47"x39", with a thickness of 4cm - 2". The standard colours are camel and anthracite coloured mixture. Various colours are available on request. Artdeck® is patented. This product is not available in North America.

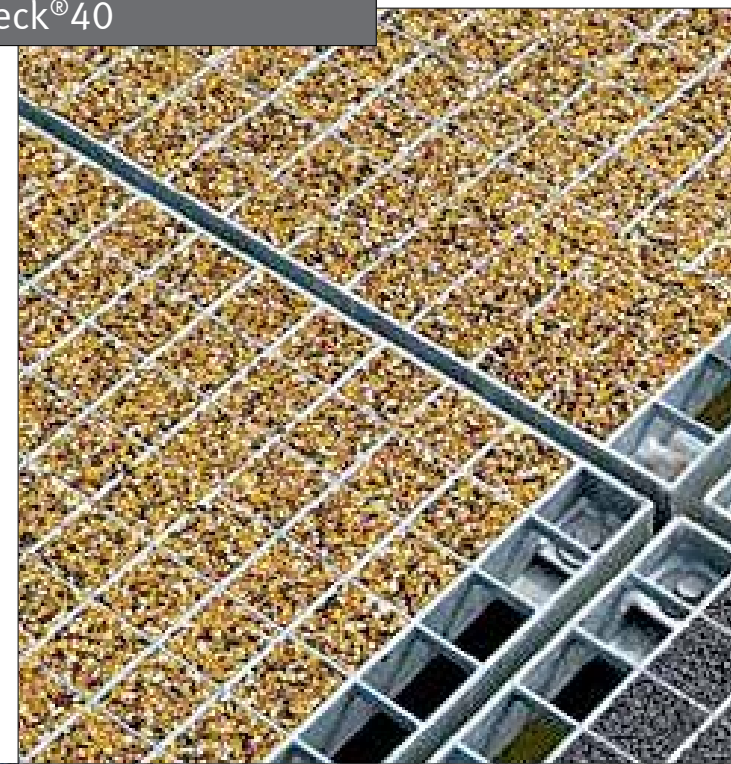

Load-bearing properties of Artdeck®:  
Streetlife's pedestrian and bicycle bridges have an even load-bearing capacity of 5 kN/m<sup>2</sup> in line with international norms. With 5 kN/m<sup>2</sup>, the heart-to-heart span is 120cm, with the application of a steel grid with a carrying bar of 4x0,3cm - 2"x0.1" and mesh width of 3,3x3,3cm - 1"x1".



Editor & Copyright: Streetlife

Graphic Design: Streetlife  
In cooperation with Coördesign

Photography: Streetlife, Tom Amoroso, Jurriaan Brobbel,  
Richard Chivers, Peterson Companies,  
Mairie de Moulins-Bourleau, Bernd Fersterra,  
Kaj van Geel, Graham Hebel, Pål Hoff AG,  
Katara Hospitality Switzerland, Matti Liski,  
Pascal Moors, Jared Steinmark, John Sturrock,  
Miro Švolík, Steve Swis

Print: H.R.G. Tiskárna

Immediately after the publication of this brochure, Collection 2016-2017, the validity of all information from previous Streetlife publications will expire. In view of the variations in material prices, we advise you always to request a quote including prices and delivery times.

The product measurements shown along with the images are always in centimeters: 234x59x72.5cm = length x width x height  
In the English issues we show rounded off inches or feet as well. Right down to the smallest details, each Streetlife design is oriented to quality and sustainability. Streetlife reserves the right to modify dimensions, specifications and prices. Due to variations in printing techniques used, colour samples printed in this brochure may differ from actual colours.